

Wheelchair Provision for Children and Adults with Muscular Dystrophy and other Neuromuscular Conditions

Best Practice Guidelines
March 2011

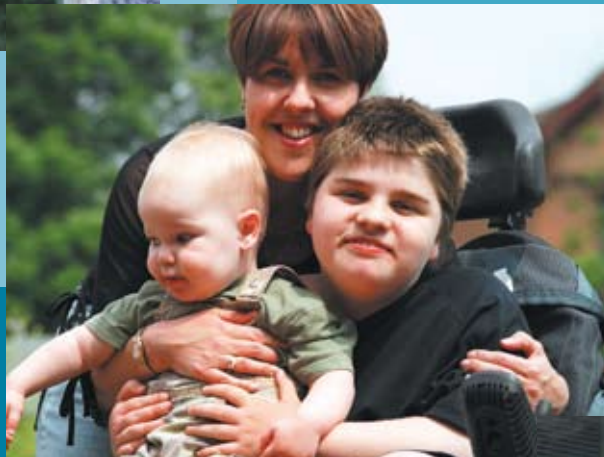

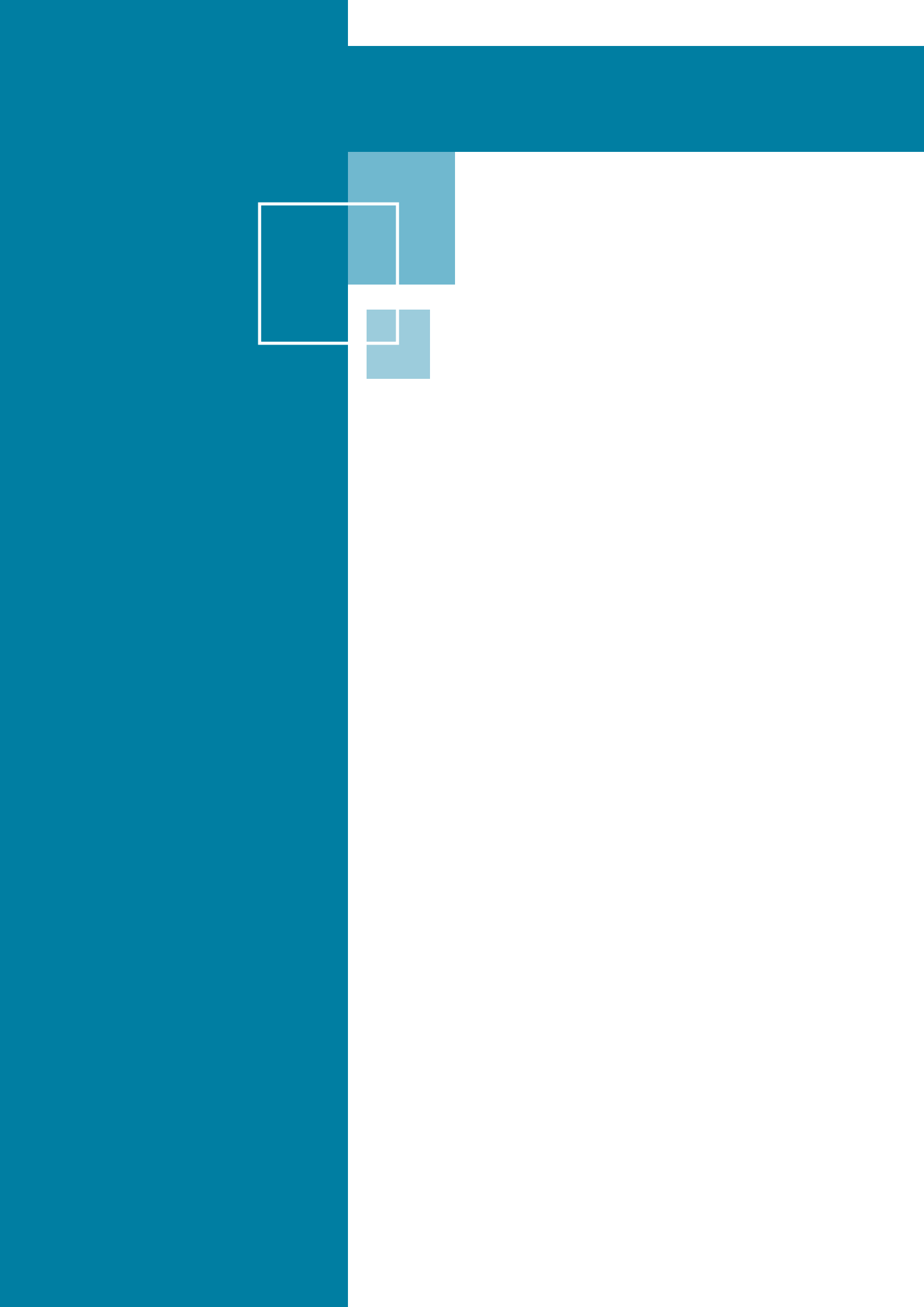

Wheelchair Provision for Children and Adults with Muscular Dystrophy and other Neuromuscular Conditions

Best Practice Guidelines
March 2011



DEVELOPING THE GUIDANCE

These guidelines have been developed by a working party co-ordinated by the Muscular Dystrophy Campaign. The working party comprised people with neuromuscular conditions, professionals from the healthcare sector, care sector, Wheelchair Services and staff from specialist voluntary organisations such as the Muscular Dystrophy Campaign, the Jennifer Trust for Spinal Muscular Atrophy and Whizz-Kidz. People with neuromuscular conditions were also interviewed about their experiences of wheelchair provision.

The material in this publication is available on the Muscular Dystrophy Campaign website at www.muscular-dystrophy.org

MEMBERS OF THE WORKING PARTY

| | |
|-------------------------|---|
| Julie Cassell | Care Advisor, Muscular Dystrophy Campaign |
| Ric Cassell | Service user, Derbyshire |
| Fiona Down | Huntingdon Wheelchair Service |
| Stella Fowler | Service user, London |
| Peter Gage | Chair, National Wheelchair Managers Forum & CSM North Essex Wheelchair Services |
| Ruth Geall | Former director of Research and Care, Muscular Dystrophy Campaign |
| Lyn Inman | Director of Education and Development, Muscular Dystrophy Campaign |
| Sue Manning | Care Advisor, Muscular Dystrophy Campaign/ Leeds Teaching Hospital Trust |
| Penny Martin | Senior Physiotherapist, Treloar College |
| Joanne McConnell | Mobility Therapist, Whizz-Kidz |
| Marina Morrow | Clinical Specialist Physiotherapist, Glasgow |
| Christopher Reed | Director of Support Services, The Jennifer Trust for Spinal Muscular Atrophy |
| Fiona Reeks | Occupational Therapist/Wheelchair and Seating Consultant |
| Terry Robinson | Specialist Neuromuscular Care Advisor, Clinical Genetics, Addenbrookes Hospital, Cambridge |
| Sarah Savage | Care Advisor, Muscular Dystrophy Campaign/Alder Hey Children's Hospital, Liverpool |
| Pauline Smith | Senior Physiotherapist, Bradford Wheelchair Service |
| Jason Watling | The Mobility Aids Centre, Stanground, Cambridgeshire |

SUPPORT FOR THE GUIDELINES

| | |
|---|---|
| Martin Chainani | Care Advisor, Muscular Dystrophy Campaign |
| Kirsty-Ann Cutler | Clinical Specialist OT, Posture & Mobility Services, West Midlands Rehabilitation Centre |
| Carolyn Hilton | Northgate & Prudhoe NHS Trust |
| Ann Dyson | Brighton Wheelchair Services |
| Dr Robert Farley | Rehabilitation Engineering Services, Edinburgh |
| Andrew Frank | Consultant in Rehabilitation Medicine, Stanmore Specialist Wheelchair Service |
| Rosalind Ham | Posture & Mobility Committee |
| Collette Hobson | Liverpool Wheelchair Services |
| David Long | PMG, Chair and Clinical Scientist, Oxford Centre for Enablement, Nuffield, Orthopaedic Centre, Oxford |
| Clare Lindsay | OT, Suffolk Social Care |
| Henry Lumley | Assistant General Manager, Musculo Skeletal Directorate, North Bristol NHS Trust |
| Geraldine Millar | Disability Services Manager, Belfast |
| Oonagh Morrison | Care Advisor, Muscular Dystrophy Campaign |
| Tony Oates | Service user, Essex |
| Dr Margaret Phillips | Senior Lecturer and Honorary Consultant in Rehabilitation Medicine |
| Marion Richardson | Paediatric Specialist, Stanmore Wheelchair Services |
| Scottish Occupational Therapy Focus Group for Muscular Dystrophy | |
| Roger Wild | Service user, Berkshire |
| Whizz-Kidz | Registered charity no. 802872 |

PRODUCTION TEAM

| | |
|----------------------------|--|
| Sally Otter | Project Manager, Muscular Dystrophy Campaign |
| Leigh Chambers | Editor |
| Jacqueline Saunders | Proof reader |
| Ruth Martin | Proof reader (second edition) |

ACKNOWLEDGEMENTS

Thank you to Invacare, Gerald Simonds Healthcare Ltd, Otto Bock Healthcare Plc, Sunrise Medical and Crown Copyright for letting us reproduce their images in chapters 6, 8 and 9, and appendix 3. Thank you also to Sunrise Medical for granting us permission to use its glossary.

CONTENTS

| | | |
|---------------------------|---|------------|
| CHAPTER 1 | Introduction and key issues | 1 |
| CHAPTER 2 | Pre-school and nursery aged children | 9 |
| CHAPTER 3 | Schoolchildren to adolescents | 25 |
| CHAPTER 4 | Adolescents to young adults | 31 |
| CHAPTER 5 | Adults | 39 |
| CHAPTER 6 | Principles of seating | 49 |
| CHAPTER 7 | Assessment guidelines | 61 |
| CHAPTER 8 | Seating and posture issues – possible solutions | 67 |
| CHAPTER 9 | Features and benefits | 9 |
| CHAPTER 10 | Planning for different environments | 87 |
| APPENDIX 1 | Neuromuscular conditions | 93 |
| APPENDIX 2 | Clinical/care management that impacts on wheelchair provision | 96 |
| APPENDIX 3 | Public transport | 99 |
| APPENDIX 4 | High performance manual wheelchairs | 102 |
| APPENDIX 5 | Funding | 103 |
| USEFUL INFORMATION | | 105 |
| GLOSSARY OF TERMS | | 111 |

FOREWORD

The Muscular Dystrophy Campaign is pleased to publish the second edition of these best practice guidelines on wheelchair provision for people with neuromuscular conditions.

For many people with a neuromuscular condition, having the right wheelchair is essential to independence and a good quality of life.

This booklet provides helpful information about the needs of both children and adults with a neuromuscular condition. It is aimed at helping staff plan appropriate wheelchair and seating provision for people with a neuromuscular condition. Although primarily aimed at Wheelchair Service staff, these guidelines are also a source of current best practice for wheelchair users living with a neuromuscular condition, their parents, their carers and other healthcare professionals.

Adequate and timely funding is often a common difficulty with NHS wheelchair provision. The Muscular Dystrophy Campaign is trying to improve this situation by lobbying the Department of Health as part of the charity's Get Moving – the case for effective Wheelchair Services campaign. It is hoped that an increase in funding for NHS Wheelchair Services will enable more people across the UK to receive the powered wheelchair they are entitled to.

This set of guidelines has been produced as a team effort and I would like to thank all the service users and professionals who contributed their time and expertise to this initiative.



Robert Meadowcroft
Chief Executive
Muscular Dystrophy Campaign
Tel: 0800 652 6352 (information line)
Web: www.muscular-dystrophy.org



A photograph showing the side profile of a person sitting in a wheelchair on a grassy field. The person is wearing a dark jacket and light-colored trousers. The wheelchair is a standard three-wheeled model with a large front wheel and two smaller rear wheels. The background is a soft-focus green field under a bright sky.

People with neuromuscular conditions have specific needs that constantly change, sometimes rapidly, as they progress. Neuromuscular disorders are often extremely limiting, causing users to become dependent upon others for all activities of daily living. Mobility is one of the few areas that with appropriate provision, people can be fully independent and this should always be the goal.

Wheelchairs and seating are vital to the lives of many people with these conditions. Appropriate provision at the right time can maximise independence and delay the onset of postural deformities. Delays and incorrect provision not only waste limited budgets but are extremely frustrating for the user and can be detrimental to their health.

The Muscular Dystrophy Campaign has been aware for a long time that wheelchair and seating provision for our client group varies considerably around the United Kingdom. Muscular dystrophies and related neuromuscular conditions are rare. The level of knowledge and understanding of the specific conditions and the issues they create is very variable.

These guidelines aim to provide helpful information about the needs of both children and adults with a neuromuscular condition. They are aimed at helping staff plan appropriate wheelchair and seating provision for people with a neuromuscular condition, ensuring a good level of service in all areas. Although primarily aimed at Wheelchair Service staff, the guidelines can also be a useful resource of best practice for users, parents, carers and other healthcare professionals.

It is vital to look at therapeutic needs, medical issues, functional abilities, associated equipment needs and the environment. In addition, it is also important to undertake a holistic assessment of the user's lifestyle. Liaison with other staff involved with the user is also essential. Correct wheelchair provision can enhance the user's level of mobility and functional ability, and greatly reduce the strain on carers. It can also help alleviate fatigue and prevent social isolation thereby lowering the risk of depression. Be aware of the particular issues affecting different age groups. *'Can the wheelchair help me get to the pub?'* is an

appropriate question for a young adult, but the most important issue for a child is likely to be getting out and about with his or her family, while continuing to work may be an essential requirement for a user with an adult onset condition. Every need should be given consideration. Even with a full assessment, it is often difficult to get provision exactly right first time so ensure regular reviews take place. Encourage the user and/or carers to inform you about any problems, and work to resolve these as quickly as possible. It is important that the user has the details of a named contact within the Wheelchair Service.

1.1 NEUROMUSCULAR ISSUES

This booklet covers all the muscular dystrophies as well as other groups of conditions that result in a similar type of muscle weakness, such as spinal muscular atrophy, various myopathies and myotonic disorders, and severe Charcot-Marie-Tooth disease. These disorders are often referred to collectively as 'neuromuscular conditions'.

See Appendix 1 for summaries of the main neuromuscular conditions. Factsheets are available on most conditions from the Muscular Dystrophy Campaign Information and Support Services on 0800 652 6352 or 020 7804 4800 or can be downloaded from **www.muscular-dystrophy.org/factsheets**
*Information about spinal muscular atrophy is available from the Jennifer Trust for Spinal Muscular Atrophy at **www.jtsma.org.uk***

Note that these conditions:

- affect adults, children and babies
- are genetic (more than one family member may be affected)
- can cause muscle weakness, in both upper and lower limbs (proximal initially) and the trunk, neck and face
- may cause weakness from birth or this may develop later
- may mean that a child can never walk independently
- are progressive (at varying rates), therefore need regular review
- many run a predictable course
- cause deformities
- do not affect sensation (apart from Charcot-Marie-Tooth disease)
- can mean that the person affected is unable to move independently
- can often cause respiratory muscle weakness
- can cause cardiomyopathy
- are currently incurable
- can cause abilities to fluctuate throughout the day, depending on activity levels and fatigue
- cause a risk of falls increase the risk of fractures, due to reduced bone density
- can cause function to be affected by changes in temperature
- can cause physical fatigue

1.2 WHEELCHAIR NEEDS

Some children with neuromuscular conditions will never be able to walk and will need to be provided with suitable wheelchairs and seating to enable them to develop independence and maximise their abilities.

For many people that are able to walk, a wheelchair will become essential at some stage. The rate of change will vary considerably from person to person, depending upon their particular condition and this will need to be taken into account when carrying out assessments and planning reviews. In most neuromuscular disorders, progression takes place

at a steady rate. Generally, once an ability is lost, it is very unlikely to be regained. Although different conditions progress at different rates, in many cases, the pattern of weakness follows a predictable course.

Weakness of muscles around the hip girdle results in a 'waddling' gait and difficulty walking distances, climbing steps, managing uneven surfaces and rising from sitting to standing. When walking, there is a tendency for the knees to 'give way', resulting in falls. Having fallen, there is extreme difficulty or, often, a complete inability to get up.

There is a risk of fractures. Despite the fact they are still able to walk, people at this stage are likely to need assessment for their first wheelchair.

Accepting the need for a wheelchair affects people differently. It may be especially hard for parents of a child with a deteriorating condition. Be sensitive to these psychological issues while emphasising that an appropriate wheelchair will help overcome fatigue and over-exertion, which may be harmful to muscles. Even if initial use is limited, having access to a wheelchair for days out, shopping trips, for example, can help a user continue normal activities while gradually coming to terms with his or her changing mobility needs. Having a wheelchair can also prevent a 'crisis' situation if a fracture is sustained in a fall. The wheelchair will, inevitably, be needed more frequently. Delaying provision of an appropriate wheelchair at this time achieves little and is likely to

cause a significant reduction in independence.

The walking ability of a person with a neuromuscular condition can vary from day to day, and even within a day, depending on activity levels. While he or she will be encouraged to walk for as long as possible, to maintain muscle strength, delay the onset of deformities and aid weight control, there comes a point when walking can only be considered therapeutic and is no longer functional. Individuals at this stage should be provided with an appropriate wheelchair to enable them to move around independently.

Many people will become dependent on a wheelchair and may need significant postural support. Because they cannot move themselves independently and are often sitting for long periods of time, they are at risk of developing pressure ulcers. Wheelchairs with specialist features can be invaluable to this group.

1.3 PLANNING AHEAD



It is essential to think and plan ahead – early referral should be encouraged. And as a provider you need to consider likely future needs. Both current and future wheelchair needs should be considered at each assessment.

People with neuromuscular conditions are generally reluctant to accept changes to seating. Encouraging compliance with using postural support at an early stage can help prevent future problems. It may be worth considering using products that can 'grow' or be adapted.

Children, particularly those with Duchenne muscular dystrophy, can rapidly deteriorate and this, combined with growth, creates constant change. Delays in assessment can cause deterioration in posture. Delays between assessment and provision may mean that a wheelchair and/or seating may no longer be suitable

by the time it is provided. Any delay can be detrimental to the health and well-being of the individual.

When planning, remember the:

- potential reluctance to accept a need for change
- progression of the condition and the need to gain compliance with supportive seating
- need to avoid delays.

Consider:

- future needs
- early provision of items that will be needed in future
- regular, automatic reviews
- adjustability in chosen products.

1.4 PROVISION

Key Issues to Consider

See chapters 6 – 9 for more information on seating, assessment and wheelchairs.

SITTING TO STANDING ABILITY

Many people with a neuromuscular condition experience considerable problems moving from sitting to standing, because of the difficulty of weight-bearing on a bent knee. Users will push up on the armrests, either facing forward using a wide based stance or turning through 180 degrees to face the chair and push up backwards.

Consider:

- seat height
- a need for powered seat height adjustment
- armrest length and height
- footplates
- moving and handling issues.

ARM FUNCTION

Detailed assessment is needed. Weakness of muscles around the shoulder girdle with preservation of strength in the forearm can give the appearance of better function

in the arm than is in fact the case. Many users will have difficulty pushing a standard manual wheelchair outside, on carpet or the slightest incline. Other terrains such as gravel, grass and soft



ground can also be particularly difficult. Some users may experience pain and/or fatigue in upper limbs. This may be a sign of overuse, and can be detrimental.

Users need independent mobility and a wheelchair that enhances their lifestyle and functional abilities. Careful consideration must be given to his or her ability to self-propel as this affects what type of manual, powered or power-assisted wheelchair is required. An attendant controlled wheelchair alone is generally not appropriate for this group of users as this can increase dependence and lower self-esteem.

Consider:

- ability to self-propel
- type of wheelchair needed.

TRUNK/NECK WEAKNESS

There is no definitive research on the correct time to introduce postural support into a user's wheelchair prescription. Expert opinion, however, suggests that it should be a proactive process beginning when the user starts to need the wheelchair on a daily basis, even though he or she may still be able to stand and walk for short distances. The adage 'prevention is better than cure' is appropriate in this case.

A wheelchair is usually needed when weakness of the proximal muscles starts to cause a user to fall frequently, he or she struggles to rise from a seated position and/or make small postural changes to aid balance when walking over uneven ground or negotiating ramps, slopes and kerbs. Although the user may be able to maintain an upright posture against gravity for short periods of time while seated, a kyphotic asymmetric posture tends to develop as muscles prematurely fatigue when the position is held for longer periods. Postural support (for example, a contoured back support and cushion) can help the individual return to a symmetrical posture^{[1] [2]}.

1. Clark J, Michael S, Morrow M (2004) Wheelchair postural support for young people with progressive neuromuscular disorders. *International Journal of Therapy and Rehabilitation* Vol.11 No.8 pp365 – 373

2. Lacoste M, Weiss-Lambrou R, Allard M, Dansereau J (2003) Powered tilt/recline systems: why and how are they used? *Assistive Technology* Vol.15 No.1 pp 58-68.

Early provision of wheelchairs with tilt-in-space and recline facilities is thought to help reduce the impact of gravity on a scoliosis.

Many users will have weak respiratory muscles which could be further compromised by straps and harnesses. Some individuals need daytime non-invasive ventilation and must carry this equipment on their wheelchair.

Weakness in the neck muscles and poor head control are common in people with neuromuscular conditions. Some users will also have difficulties in chewing and swallowing. If this is the case, liaise with his or her speech and language therapist for advice on positioning.

It is essential to assess trunk and head control on ramps and slopes.

Consider:

- the pelvis as the cornerstone of trunk and head control
- 24 hour postural management provision of good back support is essential
- early provision of equipment to provide lateral support
- early provision of postural seating
- early use of wheelchairs with tilt-in-space and recline facilities
- provision of a head support.

LEG/FOOT POSITION

Due to the nature of the conditions it is difficult to avoid the development of hip, knee, ankle and foot contractures, particularly in children. Early provision of supportive seating is desirable as this can help prevent contractures developing.

Typical problems are:

- shortening of the Achilles tendons
- plantar flexion and inversion of the foot
- hip and knee flexion contractures
- abduction and lateral rotation of the hips.

Contractures can develop very quickly, particularly if the user has outgrown the seating and/or it does not provide the correct support. Contoured cushions with wedges to discourage excessive abduction are usually beneficial. Angle adjustable footplates are essential if the Achilles tendon is shortened. Positions which encourage the development of any contractures are to be avoided. The ability to frequently change position is beneficial.

Consider:

- early provision of supportive seating to discourage deformities developing
- regular, automatic reviews.

PRESSURE REDISTRIBUTION

Although sensation is generally not affected and most people with neuromuscular conditions are not incontinent, they are at risk of pressure ulcers due to their inability to re-position themselves independently. Also, many are under or overweight which can also increase the risks considerably. Problems can arise in any area so discuss this at the assessment. Particular attention should be given to elbows and feet as well as the usual buttock/sacral regions.

OTHER ISSUES

It is vital that, when carrying out assessments, there is close liaison with all the professionals involved, as well as the user and his or her carers. Users could be encouraged to inform all relevant professionals of a forthcoming assessment.

Consider:

- daily living activities, particularly toileting
- transfers/hoisting splints/orthoses
- feeding/swallowing difficulties, other equipment e.g. mobile arm supports, ventilators

- medical issues e.g. spinal surgery, ventilatory support
- vehicle/transport issues.

Although the role of the Wheelchair Service is to assess for and provide appropriate wheelchairs and seating, during an assessment many users will mention other areas of their lives with which they are having difficulty. It may be useful to highlight other services or equipment, or suggest they contact the Muscular Dystrophy Campaign for information.

1.5 SUMMARY

Key issues to remember are:

- Neuromuscular conditions are mainly genetic with few if any treatments available. They cause progressive weakness but sensation is seldom affected.
- Mobility – “waddling gait”, difficulty standing from sitting, falls, many users are unable to walk.
- Other features are shoulder girdle weakness, poor head control, respiratory muscle weakness.
- Risks of contractures, deformities, scoliosis.
- Regular reviews are needed as deterioration can be rapid.
- Full assessment is needed. There are many issues to consider and liaison with other professionals is vital.

Wheelchairs should enhance lifestyle and enable continued independence.



Neuromuscular conditions where a wheelchair is likely to be first needed in this age group are:

- Congenital muscular dystrophies
- Congenital myopathies
- Congenital myotonic dystrophy
- Duchenne muscular dystrophy
- (Severe) Charcot-Marie-Tooth disease (also known as Hereditary, Motor and Sensory Neuropathy)
- Spinal Muscular Atrophy (all childhood types).

2.1 ABILITY AND NEEDS

Reduced self-locomotion in an infant and pre-school child as a result of neuromuscular conditions has a direct effect upon their cognitive and emotional development. Most will be unable to develop gross motor skills such as head control, bringing their hands to their mouth, sitting unaided, etc., because of low muscle tone. **However, many will have the potential for normal intellectual (cognitive) development.**

Children with physical disabilities sometimes appear to be more passive, less persistent and less motivated than their non-disabled counterparts [1]. Children who have to wait until they are five years old before they can move independently have already established 'disabled' behaviour patterns and attitudes, both in themselves and others, and these can be difficult to unlearn^[2].

1. *Fewell, R. R., & Kaminski, R. (1988). Play skills development and instruction for young children with handicaps. In S. L. Odom & M. B. Karnes (Eds.), Early intervention for infants and children with handicaps: An empirical base (pp. 145-158). Baltimore: Paul H. Brookes.*

2. *Everard (1983).*

An infant or pre-school child with a neuromuscular condition will need assistance in gaining access to a stimulating environment where they can play and interact with their peers, care givers and toys. Some children may never walk, while others will walk independently for a limited amount of time. These children have restricted experiences and opportunities for play and exploration, and view their environment from floor level or while being held in the arms of their parents. This is obviously not the experience of their able-bodied peers. All children of pre-school and nursery age need to test their environment and boundaries of behaviour. A disabled child, who is not independently mobile, will not be aware that these boundaries exist. Children with physical disabilities but with no cognitive impairment become frustrated at their functional limitations.

Many child development theories stress the importance of mobility in a child's development from a very early age.

Piaget's (1970) theory of cognitive development depends on age and is a theory of cognition, not emotions.^[3] It suggests that the ability to reason depends on mastering specific age stage skills and using these to develop future skills. This marks a series of cognitive milestones and an ongoing complex reasoning

of 'cause and effect' (termed 'sensory motor development' in the early stages). **This is an obvious indication of how immensely important independent movement is to normal development.**



"Joshua has SMA type II and has never been able to walk. He was very demanding and called all day for his parents and older sister to fetch and carry things for him, as he could not move himself. Within a week of receiving a charitable-funded powered wheelchair, Joshua had learnt about the functions of the letterbox and the fridge. His language skills also developed considerably."

Parent of a boy with SMA type II

Along with Erikson's theory of eight defined stages of psychosocial development,^[4] (which focus on the idea that a defined task or crises of each stage of development must be achieved for the child to reach full potential in the next) a more complete picture emerges of a child's need to interact fully with his or her environment. If the accessible environment is safe, along with adaptation, nurturing, and encouragement, then normal cognitive development can take place.

3. Piaget, J. (1970). Structuralism. New York: Harper & Row.

4. Erikson, E. (1950). Childhood and society. New York: Norton.

A restriction in independent mobility could jeopardise intellectual and social development as well as well-being and happiness. Providing appropriate postural support and encouraging independent mobility can overcome any deficit in motor skills and allow cognitive development to flourish.

Many studies carried out in the USA have demonstrated that providing independent powered mobility to children as young as 20 months has helped them achieve developmental milestones.

“Once our daughter got her powered chair, she suddenly bloomed into this cheeky, inquisitive and playful two-year-old. She could keep up with her sisters and became the centre of attention. Her confidence just grew and grew.”

Parent of a girl with SMA type II

Appropriate head and postural support in the right wheelchair/buggy can help children overcome many limitations and maximise their potential physical development.

Some infants remain in their ‘standard’ baby buggy as a means of suitable mobility. This choice often fits in with a family’s initial needs. It is crucial, however, that the infant’s key therapist gently guides the family towards

alternative forms of mobility (a specialist buggy or wheelchair) at the appropriate time. The key therapist can work with the Wheelchair Service to ensure that the infant is appropriately supported in a buggy. This will need to be reviewed frequently to ensure that, as the infant grows, the head is appropriately supported and the correct postural alignment is maintained.

If a child receives a powered wheelchair when young, he or she may be less self-conscious and more accepting than an older child. Providing a powered wheelchair to a child aged 16 months can open a gateway to a new social life^[5].

Research and accepted child development theories confirm that it is not appropriate for a child of 16 months to rely on adults for all his or her mobility needs. Independent mobility helps develop initiative and enable personal choice. It is vital, therefore, to a small child’s cognitive and psychosocial development that he or she can move around effectively and independently in his or her environment from an early age. As with any child, adult supervision at all times is imperative for their safety.

“It was literally within minutes of sitting in the [powered wheel]chair that he had mastered it!”

Parent of a two-year-old boy with SMA type II

5. Whizz-Kidz (2002) Powered mobility for younger children.

2.2 EMOTIONAL ISSUES

A toddler needs to develop basic autonomy, which leads to self-will. The negative counterpart to this would be expressed as self-doubt. A young child with physical disabilities may be over-protected by anxious parents who constantly help him or her and reduce the opportunities to develop skills and reach full potential. Parents of a child with a disability may assume that their child cannot accomplish anything in a normal fashion, so ignore or respond poorly to their child's efforts by removing any vestige of independence.

As self-will develops so does emotional capacity: happy, sad, contented, angry etc. Each cognitive and motor milestone reached carries with it the development of emotion.



"After a few doorframes were wrecked, he soon got the hang of it and now gets around with the skill of a rally driver. He's really happy now!"

Father of a two-year-old with SMA type II

Normal social behaviours grow with emotional and cognitive progress (which, as illustrated, relies on motor development). Providing a child with a physical disability with independent mobility complements emotional growth and maturity.

The normal emotions of a child this age may be distorted or exaggerated. The curiosity of a toddler is boundless and his or her understanding of the world is self-centred.

The table opposite shows how the appropriate mobility equipment can help young children achieve their developmental milestones^[6].

6. Sheridan, M.D. Frost, M. & Sharma, A. (1997). From Birth to Five Years: Children's Developmental Progress. UK: Routledge.

| AGE OF CHILD | NORMAL DEVELOPMENTAL MILESTONES | CHILD WITH NEUROMUSCULAR CONDITION | SEATING AND SUPPORT IN SUITABLE WHEELCHAIR/BUGGY |
|----------------|---|--|--|
| Up to 6 months | <ul style="list-style-type: none"> ■ Sits with support ■ Moves head and eyes ■ Brings hands to mouth ■ Passes objects between hands ■ Aware of feet and kicks ■ Shows excitement ■ Visually insatiable ■ Turns to mother's voice ■ Simple interaction with parents | <ul style="list-style-type: none"> ■ Unable to sit without support ■ Little or no head control ■ Limited field of vision ■ Unable to lift hand to mouth ■ Unable to bring hands to midline ■ Unable to kick legs ■ Shows excitement ■ Visually insatiable ■ Turns to mother's voice | <ul style="list-style-type: none"> ■ Good sitting posture ■ Head support and enhanced field of view ■ Tray on chair to provide upper limb support and promote hand function ■ Enables parent to interact easily with child |
| 9 months | <ul style="list-style-type: none"> ■ May sit alone ■ Attempts to crawl ■ Becomes more active with play ■ Visually attentive to people and objects in the environment ■ Regards unoffered but accessible toys appraisingly ■ Looks in the correct direction of fallen toys | <ul style="list-style-type: none"> ■ Still requires support in sitting ■ May have some head control ■ No attempt to crawl ■ Dependent on adult to pass toys and provide stimulation | <ul style="list-style-type: none"> ■ Postural support of head and trunk ■ Increase social interaction with parent/siblings ■ Secure mode of mobility |
| 12 months | <ul style="list-style-type: none"> ■ Usually crawls ■ Weight bear ■ Bottom shuffles ■ Cruises around furniture ■ Interest in outdoor activity ■ Will find hidden objects ■ Enjoys company of familiar adult | <ul style="list-style-type: none"> ■ May still require support in sitting, depending on head control ■ May not be crawling/bottom shuffling ■ May be aware of legs and able to kick | <ul style="list-style-type: none"> ■ Supported mobility for indoors/outdoors ■ Exploration of wider environment ■ Opportunities for play and development of hand function |

| AGE OF CHILD | NORMAL DEVELOPMENTAL MILESTONES | CHILD WITH NEUROMUSCULAR CONDITION | SEATING AND SUPPORT IN SUITABLE WHEELCHAIR/BUGGY |
|--------------|--|--|--|
| 15 months | <ul style="list-style-type: none"> ■ May walk alone ■ Can sit from standing ■ Kneels ■ Attempts to crawl upstairs ■ Will point to objects outdoors ■ Will push large toys ■ Scribbles with crayons etc. ■ Generally physically restless | <ul style="list-style-type: none"> ■ Needs support in sitting ■ May never be able to walk ■ Limited floor mobility or kneeling ■ Limited hand function | <ul style="list-style-type: none"> ■ Continue to explore immediate and extended environment with adult ■ Adult able to take child to toy/activity of choice ■ Access to toys and activities at different heights to interact with peers etc |
| 18 months | <ul style="list-style-type: none"> ■ Runs ■ Climbs ■ Squats to pick up toys etc. ■ Assists in dressing themselves ■ Replacing objects ■ Beginning of pretend/role play ■ Holds cup and finger feeds | <ul style="list-style-type: none"> ■ Needs to be carried ■ Unable to assist with self-care ■ Cannot initiate pretend/role play | <ul style="list-style-type: none"> ■ May be able to touch/hold toys if in supported system (multi sensory) ■ Access to different level and able to explore environment ■ May be able to hold a drink, finger feed |
| 2 years | <ul style="list-style-type: none"> ■ Runs safely ■ Climbing upstairs ■ Climbing on furniture ■ Walking backwards ■ Rides a trike ■ Throwing and kicking a ball ■ Has a hand preference ■ Imitates domestic activities ■ Follows adults around | <ul style="list-style-type: none"> ■ May not have acquired motor skills ■ Frustration may be apparent | <ul style="list-style-type: none"> ■ Suitable wheelchair with postural support enables safe exploration of environment ■ Enables some independent mobility, widening experiences and opportunities for play, e.g. follows adults around, explores wider environment ■ Participates in spontaneous games ■ Awareness of imaginary world as can view other children at appropriate level |

| AGE OF CHILD | NORMAL DEVELOPMENTAL MILESTONES | CHILD WITH NEUROMUSCULAR CONDITION | SEATING AND SUPPORT IN SUITABLE WHEELCHAIR/BUGGY |
|--------------|---|---|--|
| 2 - 3 years | <ul style="list-style-type: none"> ■ Climbs nursery equipment ■ Runs in straight line ■ Jumps ■ Manages stairs with rail ■ Self-feeding skills develop ■ Drawing shapes and lines ■ Attempts toilet training ■ Extremely active | <ul style="list-style-type: none"> ■ May not be independently feeding ■ Carried around by adult ■ Often has normal intelligence with intelligible speech | <ul style="list-style-type: none"> ■ Able to play alongside peers if in a powered wheelchair ■ Good seating will continue to promote hand function, develops self-care and fine motor skills |
| 3 years | <ul style="list-style-type: none"> ■ Can walk backwards and forwards ■ Jumps ■ Runs ■ Climbs apparatus ■ Ride a trike ■ Kicks a ball with force ■ Develops fine motor skills ■ Activities include painting, construction toys, scissor work ■ Helping with domestic tasks ■ Plays on floor for longer periods ■ Independent with personal care ■ Chooses peers to play with | <ul style="list-style-type: none"> ■ Dependent on adults for care and play ■ Limited motor skills ■ Desire to interact with peers ■ Asks many questions ■ Frustration due to physical limitations ■ Interacts with peers in vicinity only | <ul style="list-style-type: none"> ■ Keeps up with peers who now ride bikes, run etc ■ Enjoys playing with peers without adult company ■ Joins in football activities using powered wheelchair ■ Restrictions of physical limitations alleviated in accessible environments ■ Hi/lo seat on powered wheelchair enables child to play at varying levels at home/nursery etc ■ Chooses playmates and stays with chosen peers |

| AGE OF CHILD | NORMAL DEVELOPMENTAL MILESTONES | CHILD WITH NEUROMUSCULAR CONDITION | SEATING AND SUPPORT IN SUITABLE WHEELCHAIR/BUGGY |
|--------------|--|---|---|
| 4 years | <ul style="list-style-type: none"> ■ Walks and runs alone ■ Climbs up and down stairs ■ Controlled locomotor skills ■ Enjoys outdoor play ■ Hops ■ Advanced fine motor skills ■ Drawing and copying letters ■ Wants to be independent | <ul style="list-style-type: none"> ■ More insight into limitations – frustration ■ Dependent on adults to play with peer group ■ Limited spontaneous play ■ Support in floor play | <ul style="list-style-type: none"> ■ Able to play alongside peers without relying on adult to push wheelchair both indoors and outdoors ■ Enhanced independence ■ Frustrations alleviated to some extent |
| 5 years | <ul style="list-style-type: none"> ■ Advanced locomotor skills ■ Moves rhythmically to music ■ Plays ball games ■ Skips ■ Hand function more precise ■ Colouring in ■ Uses cutlery competently ■ Enjoys domestic play ■ Socially begins to select own friends | <ul style="list-style-type: none"> ■ Unable to be with selected friends if no independent mobility ■ Limited domestic play ■ Increasing frustration ■ Relies on adults for outdoor play | <ul style="list-style-type: none"> ■ Peer choice ■ Enhanced play/ self-care skills ■ Improved integration within school/nursery ■ Increased confidence and motivation |

2.3 WHEELCHAIR/BUGGY PROVISION 0 – 3 YEARS

| ISSUES | NEEDS | BENEFITS |
|---|--|--|
| Seating | <ul style="list-style-type: none"> ■ Appropriate supportive seating will enable good posture with head and spinal/trunk support and pelvic alignment ■ Adaptability is essential to accommodate the child in a number of positions, e.g. tilt-in-space/recline, lying ■ Seating system and wheelchair needs to adapt for child's growth ■ Moulded seating may be required for infants with SMA | <ul style="list-style-type: none"> ■ Minimises deformities and provides pressure redistribution if required ■ Maximises visual stimulation ■ Social interaction ■ Learning and emotional development |
| Seat elevation to and from floor level | <ul style="list-style-type: none"> ■ Ability to play/interact with peers ■ Ability to learn play and exploration skills | <ul style="list-style-type: none"> ■ Enables integration with peers ■ Promotes inclusion with family/nursery activities ■ Encourages play and exploration ■ Encourages normal developmental milestones |
| Positioning | <ul style="list-style-type: none"> ■ High risk of pressure damage to tissues ■ Curvature of spine and tilt of hips may have an affect on ability to clear secretions, functioning of micturition and defecation ■ Pressure redistribution and comfort | <ul style="list-style-type: none"> ■ Comfort and alleviation of pressure ■ Assists with positioning and management of chest secretions |
| Positioning flexibility/provision of tray | <ul style="list-style-type: none"> ■ Items need to be placed in close reach or line of sight | <ul style="list-style-type: none"> ■ Alert to environment ■ Grasps objects ■ Passes toys between hands ■ Takes hands to bottle when fed etc ■ Alleviates moving and handling risks for parent and child |

| ISSUES | NEEDS | BENEFITS |
|---|---|---|
| Space and mounting for additional equipment | <ul style="list-style-type: none"> ■ Children with a neuromuscular condition usually have low muscle tone and can be increasingly difficult to carry any distance as they grow. They may also have gastrostomy, non-invasive ventilator etc | <ul style="list-style-type: none"> ■ Child can be moved around in different environments with all vital equipment ■ Certain children may require equipment such as ventilator and oxygen which all need to be accommodated within the seating system provided |
| Ensure comfort | <ul style="list-style-type: none"> ■ Child will be seated in wheelchair for significant length of time, as little else will provide support required ■ Needs to be comfortable, 'breathable' and have extra covers ■ Pressure redistributing cushioning may also be required | <ul style="list-style-type: none"> ■ Comfort ■ Reduced anxiety ■ Pressure redistribution ■ Skin integrity ■ Maintains correct temperature of the skin ■ Reduces sweating ■ Insulates from the cold |

2.4 EQUIPMENT AND SERVICE PROVISION 3 – 5 YEARS

| ISSUES | NEEDS | BENEFITS |
|--|--|---|
| Equipment and service provision 3 – 5yrs | <ul style="list-style-type: none"> ■ As for 0 – 2yrs but also include environmental controls | <ul style="list-style-type: none"> ■ Independent mobility with integrated environmental controls allows greater access, choice and interaction with the child’s home environment |
| Seat elevation to and from floor level | <ul style="list-style-type: none"> ■ Ability to play/interact with peers ■ Ability to learn play and exploration skills | <ul style="list-style-type: none"> ■ Enables integration with peers ■ Promotes inclusion with family/nursery activities ■ Encourages play and exploration ■ Encourages normal developmental milestones |
| Specialised features | <ul style="list-style-type: none"> ■ To maintain a balance with functionality and peer interaction ■ To provide individual tailoring to match needs in achieving/ maintaining independence, growth and development | <ul style="list-style-type: none"> ■ Supportive seating ■ Joystick controls (choice of position) ■ Option for tray ■ Suitability to use over distance/rough terrain/playground ■ Speed appropriate to keep up with peers ■ Seat height adjustability to integrate at school/nursery/home ■ This age group are still very active in floor play and unless children are provided with specialised seating which lets them play at floor level they will be isolated from their peers and their learning and exploration will be hindered |

| ISSUES | NEEDS | BENEFITS |
|------------------------------|--|--|
| Environmental considerations | <ul style="list-style-type: none"> ■ To conform to the child's living and play environment | <ul style="list-style-type: none"> ■ Different functions for the child's different environments, e.g. parents may focus on toileting, school may want to ensure accessibility to switching device |
| Transportation | <ul style="list-style-type: none"> ■ Home, school, public transport etc ■ Conforms to safety standards and has clamping points | <ul style="list-style-type: none"> ■ Greater opportunity in awareness of environment ■ Promotes peer interaction outside of regular environments ■ Stimulates individual, giving greater experience of the wider world ■ Promotes self-esteem and confidence |

It is vital to a small child's cognitive and psychosocial development that, from an early age, they are able to mobilise effectively and independently in their environment.

2.5 POWERED WHEELCHAIR USE IN PRE-SCHOOL AND NURSERY AGE CHILDREN – RELATED STUDIES

Use of power mobility for a young child with Spinal Muscular Atrophy. Jones MA, McEwen IR, Hansen L. *Phys Ther.* 2003 Mar; 83(3):253-62.

Link:

www.ncbi.nlm.nih.gov/entrez/query.fcgi?cmd=Retrieve&db=pubmed&dopt=Abstract&list_uids=12620089 (abstract)

Link:

www.ptjournal.org/PTJournal/Mar2003/v83n3p253.cfm (full text)

BACKGROUND AND PURPOSE:

Young children with severe motor impairments, such as spinal muscular atrophy, are often unable to move around their environment independently. They may, therefore, be at risk of developmental delays not directly related to their motor limitations. Power mobility is an intervention that provides young children with a means of independent movement and enables them to explore their environment.

CASE DESCRIPTION:

20-month-old girl with SMA type II

INTERVENTION:

The authors provided the child with a powered wheelchair and gave her mother and physical therapist general guidelines to encourage use of the wheelchair.

OUTCOMES:

Within six weeks of receiving the powered wheelchair, the girl could operate it independently. She showed developmental gains in all domains of the Battelle Developmental Inventory and the Paediatric Evaluation of Disability Inventory over six months. The authors conducted an interview with the child's mother before and after intervention. She reported that the child was more independent after receiving the powered wheelchair.

DISCUSSION:

The powered wheelchair may have been associated with the child's developmental changes over six months.

Cognitive predictors of young children's readiness for powered mobility. Tefft D, Guerette P, Furumasu J. *Dev Med Child Neurol*. 1999 Oct; 41(10): 665-70.

Link:

www.ncbi.nlm.nih.gov/entrez/query.fcgi?cmd=Retrieve&db=pubmed&dopt=Abstract&list_uids=10587042 (abstract)

Link:

www.ranchorep.org/Cognitive_pm_article.html (full text)

Independent mobility in early childhood has been associated with the development of various cognitive and psychosocial skills. Children with physical disabilities cannot always move independently and may be at risk of delay in these areas. Early provision of powered mobility can offer independent mobility to young children.

Despite this, there is little information to help determine when a young child has the cognitive skills necessary to safely operate a powered wheelchair. This current research aims to identify these skills. A cognitive assessment battery and a wheelchair mobility training and

assessment programme were developed. Twenty-six children with physical disabilities, between the ages of 20 and 36 months, were evaluated on a cognitive assessment and participated in a wheelchair training and assessment programme. A stepwise regression analysis was used to determine which of the cognitive skills predicted wheelchair mobility performance. The cognitive domains of spatial relations and problem solving were found to be significant and accounted for 57 percent of the variance in wheelchair skills. Developmental cut-off points on these scales, as they relate to wheelchair skills, are presented and clinical applications are discussed.

The development of a powered wheelchair mobility programme for young children.

Jan Furumasua, Paula Gueretteb, Donita Tefft. *Technology and Disability* 5 (1996) 41-48

Link: www.ranchorep.org/techdis.htm (full text)

ABSTRACT:

While early independent mobility may have positive effects on a child's development, it is still difficult for a clinician to determine when a child is developmentally ready to operate a powered wheelchair. The Rehabilitation Engineering Research Centre at Rancho Los Amigos Medical Centre in Downey, California has undertaken a project to develop a cognitive assessment battery to predict a young child's functional performance in a wheelchair. The first phase of this project – the

development of a powered mobility program (PMP) – is presented here. A 34-item assessment battery was developed through task analysis and input from professionals who train children in mobility skills. The battery includes basic, structured and unstructured wheelchair skills. A flexible approach for administering the PMP is presented, as well as findings from 24 children between the ages of 18 and 36 months who were evaluated using the PMP.

Effects of powered mobility on self-initiated behaviours of very young children with locomotor disability.

Butler C. *Dev Med Child Neurol* 1986 Jun; 28(3): 325-32

Link: [www.ncbi.nlm.nih.gov/entrez/query.fcgi?](http://www.ncbi.nlm.nih.gov/entrez/query.fcgi?cmd=Retrieve&db=pubmed&dopt=Abstract&list_uids=2941328)

cmd=Retrieve&db=pubmed&dopt=Abstract&list_uids=2941328
(abstract)

This study reports the effects of powered mobility on the self-initiated behaviour of six children with various disabilities who, between 23 and 38 months of age, learnt to use powered wheelchairs in less than three weeks. Using a multiple baseline design, two-hour observation periods were video-recorded at 10-day intervals before and after

they achieved independent mobility. Frequency of self-initiated interaction with objects, spatial exploration and communication with carers were analysed. Three children increased all three types of behaviour; one increased in two types but decreased in interaction with objects; and two increased in spatial exploration only.

Motorized wheelchair driving by disabled children.

Butler C, Okamoto GA, MaKay TM Arch *Phys Med Rehabil* 1984 Feb; 65(2) 95-7

Link: [www.ncbi.nlm.nih.gov/entrez/query.fcgi?](http://www.ncbi.nlm.nih.gov/entrez/query.fcgi?cmd=Retrieve&db=pubmed&dopt=Abstract&list_uids=6230066)

cmd=Retrieve&db=pubmed&dopt=Abstract&list_uids=6230066
(abstract)

Thirteen children with physical disabilities, normal intelligence and stable family situations were studied to learn whether children under four years old could learn to control a powered wheelchair competently. Their mean age was 31.3 months (range 20 to 37 months). There were six girls and seven boys. Each child required adaptive seating to manipulate the control stick in a conventional powered wheelchair. Without specific training instructions, parents introduced the wheelchairs under pleasant circumstances at home. Daily logs and engine-hour-meters indicate that 12 children learned seven pre-established driving skills within a mean cumulative period of 34.4 hours

(range 6.6 to 168 hours) distributed over an average 16.3 days (range 3 to 50 days). Actual cumulative wheelchair movement averaged 8.1 hours (range 1.7 to 26.1 hours). All learned a cluster of four to five skills over a one to five day period. Start-stop and circling were the two initial skills in all but one case. In four children, the first skill appeared after a latent period of 5, 6, 12 and 43 days. Children as young as 24 months can learn to drive powered wheelchairs. Because of the theoretical importance of approximating normal gross motor milestones, powered mobility should be considered an early rehabilitative intervention for physically disabled children.

Powered mobility for very young disabled children.

Butler C, Okamoto GA, MaKay TM. *Dev Med Child Neurol* 1983 Aug;25(4):472-4

Nine motor-disabled children with normal intelligence and varying degrees of disability were studied to see if competent control of a powered wheelchair is attainable between 20 and 39 months of age. Each child used a conventional powered wheelchair with adaptive

seating. Parents supervised the learning at home. Eight children drove safely and independently within 1.7 to 12 hours accumulated over a one to seven-week period. Parents reported that this independent mobility stimulated their child's social, emotional and intellectual behaviour.

NEUROMUSCULAR CONDITIONS

This chapter addresses the continuing needs of children with the following conditions:

- Congenital muscular dystrophies
- Congenital myopathies
- Congenital myotonic dystrophy
- Duchenne muscular dystrophy
- Severe Charcot-Marie-Tooth disease (also known as Hereditary, Motor and Sensory Neuropathy)
- Spinal Muscular Atrophy (all childhood types).

Schoolchildren may need a wheelchair for the first time if they have one of the following neuromuscular conditions:

- Congenital myopathies
- Congenital myotonic dystrophy
- Duchenne muscular dystrophy
- Facioscapulohumeral muscular dystrophy (FSH)
- Limb girdle muscular dystrophies
- Severe Becker muscular dystrophy
- Severe Charcot-Marie-Tooth disease.

INTRODUCTION

This age is a time of ongoing change for children as they move through childhood to adolescence. They are beginning to develop independence in many areas of everyday life, while consolidating early-learnt skills. At play and school, they start to undertake activities independently from their parents and other close adults. This is important as it helps them develop their individuality and build self-esteem. Children begin to learn right from wrong and the consequences of actions, both for themselves and others. There is so much to learn and it is a very exciting time for a child.

Children start to become interested in how they look, and want to be accepted by friends. They experiment with forming friendship groups and develop close relationships.





For many children with a neuromuscular condition, however, this is the time when they start to lose muscle strength and become more physically dependent. These children are coping with many changes to their bodies – the deterioration of physical skills and function – and becoming more aware of how they are different from others.

During this period, many children will lose the ability to walk independently. A wheelchair plays a vital role in enabling the child to continue developing and learning alongside friends and family. Wheelchair therapists have the ability to play a crucial part in promoting this process by assessing for and providing the appropriate wheelchair.

"My proudest moment at primary school was when I did my cycling proficiency. Well, there was a wheelchair one too, on stuff like driving. I did that and got a bronze award. I was called out in assembly alongside the people who'd done the cycling tests, so that was good."

Tom, 18 (SMA type II)

3.1 ABILITY AND NEEDS

CHILDREN WITH ONGOING NEEDS

Some children, who were diagnosed with a neuromuscular condition during their early years, may already be using a wheelchair to maintain their mobility. They will have a continuing mobility need which should be reviewed regularly. Like all children with a physical disability, they require frequent reassessment as they grow and their functional needs change.

CHILDREN WITH EMERGING NEEDS

Some children, those with Duchenne muscular dystrophy for example, may still be walking independently. However, changes in motor skills will become more apparent as they get older and their muscles weaken. These children may tire and fatigue more than their peers and reduced muscle strength may cause problems with balance and frequent falling.

"I felt much better once I had my wheelchair at school. I used it in the playground to begin with. I was happy because I could keep up with the others and I didn't need anyone with me in case I fell over."

Joe, 13 (Duchenne muscular dystrophy)

Many of these conditions follow a predictable course so it is possible to forecast how a condition will affect a child as he or she grows older. Work with parents and local healthcare staff to establish an accurate diagnosis, if possible, as this helps wheelchair providers plan ahead and ensure the child's needs are met.

Given the often predictable, progressive nature of many of these conditions it is possible to plan ahead, and it is important to work to maintain the best possible sitting posture as loss of muscle power occurs.

The loss of independent mobility is a challenging time for children, as they face the transition from walking to using a wheelchair. This is often extremely hard as parents, siblings, extended family and friends, begin to adjust to life in a different way.

FACTORS TO CONSIDER

- Increasing muscle weakness
- Limited walking ability with eventual loss of mobility
- Increased levels of fatigue
- Problems with balance
- Tendency to fall which may cause injury
- Use of long leg callipers (KAFOs) to prolong ambulation
- Psychosocial development
- Transition from walking to wheelchair use
- Sitting posture.

3.2 PROVISION

KEY ISSUES TO CONSIDER

Planning ahead can ease the transition from walking to using a wheelchair, for both child and family. Providing a wheelchair for a child with decreasing mobility skills should be a very positive step, as it will increase the child's independence. Parents should be encouraged to present the wheelchair in a positive light.



Professionals have an important role in working closely with families to enable everyone to see the wheelchair as a positive provision that will not only increase the child's mobility and independence but also enable him or her to function more effectively and participate fully in activities with friends.

Carers also need to be considered. Introducing the idea of the first wheelchair raises issues for parents regarding access in the home environment and transport. Many will have planned ahead but others must face the realisation that changes will be needed at home. The Muscular Dystrophy Campaign publishes an Adaptations Manual to help parents and professionals plan a wheelchair accessible environment at home and school.

Families also need to consider the type of vehicle they use. Specialist information and advice is available from Disabled Living and Mobility Centres as well as

local vehicle dealerships and specialist firms experienced in adapting vehicles to accommodate wheelchairs.

A mobile child should be provided with a wheelchair when he or she is beginning to experience mobility difficulties and prior to self-limitation so that energy can be conserved for enjoyable activities. Children may have falls as their muscles weaken, which can cause injury and affect confidence. Introducing the wheelchair for part-time use at this stage can prevent serious injury – such as fractures, which are more likely to occur in children with neuromuscular conditions as they have reduced bone density – and enhance confidence.

“When I got my powered chair, it was great. I could move about again and go to cubs with my friends; they all thought it was cool.”

Ben, 11 (Duchenne muscular dystrophy)

Issues for children aged 5 – 13 are shown below.

See chapters 6 – 9 for further information on seating, assessment and wheelchair features

| ISSUES | NEEDS | BENEFITS |
|-------------------|---|---|
| Seating | <ul style="list-style-type: none"> ■ Appropriate supportive seating will enable good posture with head and spinal/trunk support and pelvic alignment ■ Adaptability is essential so the child can be accommodated in a number of positions e.g. tilt-in-space/recline, lying ■ Seating system and wheelchair needs to adapt for the child's growth | <ul style="list-style-type: none"> ■ Minimises deformities and provides pressure redistribution if required ■ Maximises visual stimulation ■ Enables social interaction ■ Stimulates learning and emotional development |
| Positioning | <ul style="list-style-type: none"> ■ Ability to alter position independently | <ul style="list-style-type: none"> ■ Tilt-in-space may assist with positioning, pressure redistribution and management of personal care ■ Assists carers with moving and handling ■ Helps maintain comfort and reduces fatigue |
| Provision of tray | <ul style="list-style-type: none"> ■ Support for upper limbs is essential due to weakness | <ul style="list-style-type: none"> ■ Maximises upper limb and hand function ■ Maintains independence |
| Aesthetics | <ul style="list-style-type: none"> ■ Child becomes more aware of body image/esteem ■ Include child in assessment, e.g. offer choice of colour | <ul style="list-style-type: none"> ■ Empowers child and increases confidence |

| ISSUES | NEEDS | BENEFITS |
|--------------------------------|---|--|
| Comfort | <ul style="list-style-type: none"> ■ Assessment of pressure redistributing cushioning will be required | <ul style="list-style-type: none"> ■ Improves quality of life |
| Space for additional equipment | <ul style="list-style-type: none"> ■ Certain children may require equipment such as suction, ventilator and oxygen which all need to be accommodated within the seating/wheelchair | <ul style="list-style-type: none"> ■ Child can be moved around in different environments with all vital equipment |
| Environmental controls | <ul style="list-style-type: none"> ■ Child may be assessed for an environmental control system which may need to be accommodated on the chair | <ul style="list-style-type: none"> ■ Increases independence |

Appropriate wheelchair provision is vital to enable the child to develop independence – physically, socially and emotionally.

4

ADOLESCENTS TO YOUNG ADULTS



NEUROMUSCULAR CONDITIONS

This chapter addresses the continuing needs of adolescents and young adults with the following conditions:

- Becker muscular dystrophy (more severe phenotype)
- Congenital muscular dystrophies
- Congenital myopathies
- Congenital myotonic dystrophy
- Duchenne muscular dystrophy
- Facioscapulohumeral muscular dystrophy (FSH)
- Limb girdle muscular dystrophies
- Severe Charcot-Marie-Tooth disease
- Spinal Muscular Atrophy.

Adolescents or young adults may need a wheelchair for the first time if they have one of the following neuromuscular conditions:

- Becker muscular dystrophy
- Facioscapulohumeral muscular dystrophy (FSH)
- Limb girdle muscular dystrophies.

INTRODUCTION

Young people become increasingly independent in all aspects of their lives. They go out and meet friends, form relationships, follow their interests and hobbies, participate in a range of activities and begin to think about future educational, employment and social opportunities.

Young people with neuromuscular conditions – like any other member of society – have a right to and should expect:

- access to independence
- accessible home environments



- accessible educational environments
- accessible work environments
- access to transport
- to be comfortable
- to choose how they look
- to feel empowered to make own life choices
- to have positive self-esteem.

4.1 ABILITY AND NEEDS

Adolescents and young adults with a progressive neuromuscular condition become more dependent on their parents, carers and friends for their practical and social needs, mobility and for help with activities of daily living. Rapid progression of the condition, combined with growth, means an individual's needs and abilities are constantly changing. Once an ability is lost it is very unlikely to be regained.

As their condition progresses and their mobility deteriorates, young people have to come to terms with increasing disability, the need for a wheelchair and being unable to keep up with peers or participate in activities they have previously enjoyed. Loss of independence for this age group is likely to be a major area of concern and can often cause feelings of isolation and even depression. By this stage, a young person with a neuromuscular condition may be completely dependent on a powered

wheelchair for indoor and outdoor mobility. The transition from walking to using a wheelchair permanently can be very emotionally and physically challenging for the user and his or her family and friends.

Provision of the correct wheelchair and seating system is likely to be one of the most critical factors in helping to alleviate dependency and the sense of isolation.



Looking and feeling good will also be important for this age group. Young people want to increase their independence from parents and make the most of their lives. This involves exploring the wider world by themselves as well as forming and maintaining relationships. They need to be able to stay up, go out late, socialise with friends, follow interests such as sport, music, shopping, films, computers and play stations, pubs and clubs.



While their lives may be limited, they want and need to be able to live them to the full.

"My new powered wheelchair means I can take my dog for a walk round the field on my own."

Caroline, 17

FACTORS TO CONSIDER:

- A rapid growth spurt during early teenage years can result in significant postural changes including development of contractures
- Spinal surgery may be considered at this stage to correct severe and increasing scoliosis. Various related issues will impact on wheelchair provision
- There will be increased weakness in the upper limbs
- Head control may be poor and support will be needed
- Assisted standing, even when the young person is unable to walk, can help maintain bone density, prevent/delay the development of contractures and assist with kidney, bladder and gastro-intestinal function
- Respiratory muscles may be weakened
- Up to 15 hours a day could be spent in a wheelchair, so comfort and pressure redistribution will be important issues
- Possible oedema/swelling of the feet and ankles
- Some young people may be very thin and others may be obese.

4.2 PROVISION

KEY ISSUES TO CONSIDER

This is a time of changing needs and regular six to twelve monthly assessments and reviews will be required to consider current and future needs.

There is no definitive research on the correct time to introduce postural support into the wheelchair prescription of a user with a neuromuscular condition. Expert opinion, however, suggests that it should be a proactive process beginning when the user starts to need the wheelchair on a daily basis, even though he or she may still be able to stand and walk for short distances. When seated, the user is likely to be able to maintain an upright posture against gravity for short periods of time. However, when remaining in the position for longer periods, a kyphotic asymmetric posture tends to develop because muscles prematurely fatigue. Postural support, such as a contoured back support and cushion, can help the individual return to a symmetrical posture.

Consider both the therapeutic plans of the supervising team and the lifestyle wishes of the user/family. A wheelchair with appropriate postural support and specialist functions needed by the user for his or her lifestyle will help maintain independence and function.

Users may be unable to change their sitting position or redistribute pressure independently. Sitting in a wheelchair for up to 15 hours a day may cause pain and discomfort, associated with deformity and inactivity. Specialist powered functions such as tilt-in-space, back recline and elevating leg rests can enable users to independently change their position and relieve any pressure or discomfort. Powered tilt-in-space and back reclines also allow users to move independently in their wheelchairs and enable them to control functions, which may otherwise be controlled by someone else.

Independently supplied backrest reclines can cause problems with positioning, such as increased lordosis and a forward sliding pelvis. Shearing may cause increased pressure problems and recline is best when used in conjunction with tilt-in-space. The amount of tilt required needs to be assessed on an individual basis.

A wheelchair is the legs of the user.

Any wheelchair provided needs to be reliable and access to an efficient repair service is essential. If a powered wheelchair breaks down, the user can lose independence, access to education/work and be unable to sit comfortably. Consider the speed and range of the wheelchair

required to provide the user with independent outdoor mobility in a variety of environments and on a range of terrains. In addition, the user, like any other young person, will want to look good and 'street credibility' will be important to him or her.

The therapeutic goal is to provide appropriate support balanced with adequate freedom of movement, critical for the user to retain and maintain function.

Issues for adolescents and young adults are shown below.

It is quite rare to get the prescription absolutely right first time but regular reviews will help.

See chapters 6 – 9 for further information on seating, assessment and wheelchair features.

| ISSUES | NEEDS | BENEFITS |
|--|--|--|
| Seating | <ul style="list-style-type: none"> ■ Appropriate supportive seating will enable good posture with head, spinal and trunk support and pelvic alignment ■ Seating system and wheelchair should be adaptable to the user's growth and be able to accommodate him or her in a number of positions e.g. tilt-in-space/recline/lying | <ul style="list-style-type: none"> ■ Minimises or delays development and severity of postural deformities ■ Maintains comfort ■ Provides pressure redistribution ■ Maintains function ■ Enables social interaction ■ Maximises visual stimulation ■ Aids learning and emotional development |
| <p>Standing</p> <p>It is likely there will be no functional walking in long leg callipers.</p> <p>Use of a standing frame or long leg callipers is likely to be impractical in a large secondary school.</p> | <ul style="list-style-type: none"> ■ A wheelchair with powered stand facility will enable the user independent standing. This needs to be considered while he or she is still in long leg callipers so the transition is a smooth one | <ul style="list-style-type: none"> ■ Continued standing can help maintain bone density, delay contractures, assist with kidney, bladder and gastro-intestinal function. It can also be of enormous psychological benefit^[1] |

1. National Clinical Guidelines for Specialised Wheelchair Seating, British Society of Rehabilitation Medicine, April 04.

| ISSUES | NEEDS | BENEFITS |
|---|---|--|
| Scoliosis | <ul style="list-style-type: none"> ■ Spinal surgery may be considered ■ Issues relating to scoliosis and spinal surgery will impact on wheelchair provision ■ Following surgery, all seating should be reassessed ■ User will need to be able to independently alter his or her position, using powered tilt-in-space | <ul style="list-style-type: none"> ■ Maintains functional abilities ■ Reduces fatigue levels ■ Improves comfort |
| <p>Respiratory issues</p> <p>As muscular dystrophy progresses it can weaken respiratory muscles. This can be particularly serious at night and ventilation may be required</p> <p>As the condition progresses further, the user may also need daytime ventilatory support</p> | <ul style="list-style-type: none"> ■ Some young people may require equipment such as ventilator, suction and oxygen. There needs to be space within the seating/wheelchair to accommodate this additional equipment | <ul style="list-style-type: none"> ■ User can move independently in different environments with all vital equipment ■ Maintains independence ■ Improves quality of life |
| <p>Fatigue levels</p> <p>As the conditions progress, increased fatigue is common</p> <p>The user (particularly boys in the later stages of Duchenne, following spinal surgery) may need to rest in the wheelchair during the day</p> | <ul style="list-style-type: none"> ■ Provision of powered tilt-in-space | <ul style="list-style-type: none"> ■ Enables the user to change position independently and helps avoid the need to go to bed ■ Assists with pain management |
| Poor head control | <ul style="list-style-type: none"> ■ Headrest with height, forward/backward/side ways adjustment | <ul style="list-style-type: none"> ■ Provides support for the head ■ Used with tilt-in-space, it enables the user to lie back with head well supported |

| ISSUES | NEEDS | BENEFITS |
|--|---|--|
| Weight | <ul style="list-style-type: none"> ■ Some young people may be very thin and some may be obese. Specialised seating and postural support with adequate pressure redistribution is required | <ul style="list-style-type: none"> ■ May help minimise and/or delay development of deformities ■ Provides a good, comfortable, postural position ■ Redistributes pressure |
| Positioning | <ul style="list-style-type: none"> ■ Ability to change position independently | <ul style="list-style-type: none"> ■ Tilt-in-space may assist with pressure redistribution ■ Helps maintain comfort ■ Assists with positioning ■ Assists with management of personal care ■ Assists carers with moving and handling |
| Aesthetics | <ul style="list-style-type: none"> ■ User increasingly aware of body image ■ Importance of self-esteem ■ Inclusion in choice of colour | <ul style="list-style-type: none"> ■ Empowers user and increases confidence |
| <p>Appropriate mounting and function of joystick control</p> <p>Type of joystick control</p> | <ul style="list-style-type: none"> ■ Adequate access to desks, tables and work surfaces ■ Independence in moving wheelchair ■ Maintain optimum seating position ■ Increased weakness in upper limb/hand function may make it difficult to use standard joystick controls ■ Alternatives need to be assessed ■ Light touch or sensitive joystick may be required ■ Different or repositioned switches may be required to change speed or function | <ul style="list-style-type: none"> ■ Helps maintain functional skills ■ Ensures user does not have to lean towards or away from control to obtain optimum leverage ■ Maintains independence |

| ISSUES | NEEDS | BENEFITS |
|------------------------|--|---|
| Tray | <ul style="list-style-type: none"> ■ Support for upper limbs essential due to increasing upper limb weakness ■ Forward/backward adjustability provides optimum position to ensure maximum hand function ■ Different activities may require different position | <ul style="list-style-type: none"> ■ Ensures optimum support for user's arms ■ Maximises upper limb and hand function ■ Maintains independence |
| Environmental controls | <ul style="list-style-type: none"> ■ User may be assessed for an environmental control system to use in conjunction with wheelchair | <ul style="list-style-type: none"> ■ Increases independence ■ Improves quality of life |

Appropriate and suitable equipment enables people with neuromuscular conditions to live an active teenage/young adult lifestyle, to be significantly more comfortable and to be as independent of carers as possible. This can make a major difference to their self-esteem, quality of life and level of independence.

NEUROMUSCULAR CONDITIONS

This chapter addresses the continuing needs of adults with the following conditions:

- Becker muscular dystrophy
- Charcot-Marie-Tooth disease
- Congenital muscular dystrophies
- Congenital myopathies
- Congenital myotonic dystrophy
- Duchenne muscular dystrophy
- Facioscapulohumeral muscular dystrophy (FSH)
- Limb girdle muscular dystrophies
- Spinal Muscular Atrophy (types II and III).

Adults may need a wheelchair for the first time if they have one of the following neuromuscular conditions:

- Becker muscular dystrophy
- Congenital myopathies
- Facioscapulohumeral muscular dystrophy (FSH)
- Limb girdle muscular dystrophies
- Myotonic dystrophy
- Spinal Muscular Atrophy (adult onset).

INTRODUCTION

Neuromuscular conditions can often be extremely debilitating and many users become dependent on others for all activities of daily living. Mobility is one of the few areas that with appropriate provision, people can be fully independent and this should always be the goal. The correct wheelchair can enhance learning and concentration, reduce fatigue, and prevent social isolation, thereby reducing the likelihood of depression. It can also greatly reduce the strain on carers.



Adults are entitled to:

- independence
- an accessible home environment
- an accessible work environment
- a social life
- form/maintain relationships
- have children and/or care for children
- accessible transport.

5.1 ADULTS WITH ONGOING NEEDS

Those young adults who were severely affected by a neuromuscular condition as a child will need continued reviews of their wheelchair and seating needs. They may now wish to attend assessments without their parents or, if they had a wheelchair provided by a charity, return to Wheelchair Services after a break.

By the time they reach adulthood, most of this group will have very little active movement and function will be severely limited. They are also likely to have significant postural deformities. They may use environmental controls (*see appendix 2*) or powered mobile arm supports (*see appendix 2*) to assist with independence. Many will be using non-invasive ventilation to assist with breathing at night (*see appendix 2*) and some may

also need it during the day. Some of these adults will have problems with circulation and be prone to fatigue. All these factors need to be considered when assessing for suitable wheelchairs and seating.

FACTORS TO CONSIDER:

- Significant postural deformities
- Poor head and/or trunk control
- Poor arm function (possible use of mobile arm support)
- Possible difficulty using standard joystick controls
- Risk of developing pressure areas
- Fatigue
- Need to carry a ventilator on the wheelchair for daytime use
- Possible use of environmental control systems
- Possible oedema/swelling of the feet/ankles.

5.2 PROVISION

KEY ISSUES TO CONSIDER

A full and detailed assessment will be required, as well as liaison with the user, carers and relevant professionals. **A wheelchair is the legs of the user so any**

wheelchair provided needs to be reliable. Consider the speed and range of the wheelchair as it needs to provide adequate independent outdoor mobility in a variety of environments and on a range of terrains.



It is essential that the seating position can be changed to help redistribute pressure as this will improve comfort and enable independence. Supportive, pressure redistributing seating along with powered tilt-in-space, backrest recline and elevating leg rests, allow the user to control functions which may otherwise have to be operated by someone else. Backrest recline should only be used in conjunction with tilt-in-space. Using a backrest recline independently can cause

positioning problems (such as increased lumbar lordosis, forward sliding of the pelvis), and increase pressure problems due to shearing.

Other modifications and features may be needed. Careful consideration should be given to the type of control, and its positioning, to ensure the functions can be operated independently by the user. If the user is working, it may be helpful to talk to the Access to Work team about help with funding any extra wheelchair functions needed for his or her job.

Transfers in and out of a vehicle may be difficult and some users may opt to travel in their wheelchair.

Planned reviews are essential because adults' needs change as the condition progresses.

Issues specific to adults with ongoing needs are shown below.

See chapters 6 – 9 for further information on seating, assessment and wheelchair features.

| ISSUES | NEEDS | BENEFITS |
|--|--|---|
| Postural deformities – fixed or mobile | <ul style="list-style-type: none"> ■ Supportive seating will accommodate or correct postural deformities ■ Correctly fitting wheelchair ■ Correctly positioned controls | <ul style="list-style-type: none"> ■ Minimises further deterioration ■ Reduces risk of pressure problems ■ Improves user's comfort |
| Poor head/trunk control | <ul style="list-style-type: none"> ■ Adequate well-fitting head support ■ Appropriate supportive seating ■ Tilt-in-space facility | <ul style="list-style-type: none"> ■ Reduces risk of neck injury ■ Provides user with independence on ramps and slopes ■ Reduces risks of falling forward from wheelchair ■ Reduces need for restrictive harnesses/straps etc |

| ISSUES | NEEDS | BENEFITS |
|--|---|--|
| Pressure problems | <ul style="list-style-type: none"> ■ Assessment for pressure redistributing seating/backrest ■ Powered tilt-in-space facility ■ Assessment of other 'at risk' areas, e.g. feet, elbows | <ul style="list-style-type: none"> ■ Minimises risk of pressure problems ■ Gives user ability to change position independently |
| Difficulty using standard joystick | <ul style="list-style-type: none"> ■ Full consideration of alternative controls, e.g. mini joysticks, switches | <ul style="list-style-type: none"> ■ User able to control wheelchair and powered functions independently |
| Fatigue | <ul style="list-style-type: none"> ■ Powered tilt-in-space ■ Possible powered recline with elevating leg rests | <ul style="list-style-type: none"> ■ Allows user to alter position and rest when necessary ■ Reduces need for carer input and/or transfers, e.g. to bed ■ Enhances ability to study, work and socialise |
| Oedema of feet/ankles | <ul style="list-style-type: none"> ■ Powered elevating leg rests (if no fixed contractures) ■ Tilt-in-space facility | <ul style="list-style-type: none"> ■ User can alter leg/foot position |
| Extra equipment, e.g. ventilator, powered mobile arm support, environmental controls | <ul style="list-style-type: none"> ■ Full assessment ■ Modifications to allow essential equipment to be carried on wheelchair, following risk assessment | <ul style="list-style-type: none"> ■ Provides user with maximum possible independence |

5.3 ADULTS WITH INCREASING NEEDS

The walking ability of a person with a neuromuscular condition can vary from day to day, and even within a day, depending on activity levels. While he or she will be encouraged to walk for as long as possible, to maintain muscle strength, delay the onset of deformities and aid weight control, there comes a point when walking can only be considered therapeutic and is no longer functional. Individuals at this stage should be provided with an appropriate wheelchair to enable them to move around independently.

The psychological impact of completely losing the ability to walk causes difficulty for many adults. Helping them stay as independent as possible, by providing a wheelchair to suit their environmental, social and transport needs, can help to overcome this difficulty. Some

of this group (very few) will have some postural deformities and others are at risk of developing them through incorrect wheelchair provision or inadequate/inappropriate support. They are likely to have shoulder girdle weakness and the impact of this needs to be fully investigated.

FACTORS TO CONSIDER:

- Enabling/maintaining independence
- Access within the home, further education and work environments
- Psychological impact of loss of walking ability
- Need for postural support/comfort
- Difficulty with transfers
- Transport/driving
- Reduced arm function (may be using a mobile arm support).

5.4 PROVISION

KEY ISSUES TO CONSIDER

A full detailed assessment will be needed as well as liaison with the user, carers and relevant professionals. **A wheelchair is the legs of the user so any wheelchair provided must be reliable.**

If a user can propel a manual wheelchair, both indoors and outdoors, and use such a chair to maintain independence, then this should be encouraged.

Consideration may be given to high performance manual wheelchairs (see appendix 4) or power assist kits (see chapter 9). However, many users will need an indoor/outdoor powered wheelchair. Those with postural deformities will also require appropriate corrective or accommodating seating. Those with no postural deformities will benefit from some degree of specialised seating. When sitting

for prolonged periods they are likely to develop a kyphotic asymmetric posture due to premature fatigue of the muscles. Provision of a contoured cushion and back support will enable them to return to a symmetrical position.

The psychological impact of the loss of walking ability is immense and needs to be handled sensitively. The transition from walking to using a wheelchair can also cause difficulties with access in the home, work and/or further education environment. Many users will have planned ahead – which helps ease the transition – but others must face the realisation that changes are needed. The Muscular Dystrophy Campaign publishes an Adaptations Manual^[1] to help users and professionals plan suitable wheelchair-accessible environments.

If the user is working, it may be helpful to talk to the Access to Work team about help with funding for adaptations and extra, or specialist, wheelchair functions which the user needs to carry out his or her job.

Consider the user's vehicle and whether alterations are needed. Specialist information and advice is available from Mobility Centres, local vehicle dealerships and specialist firms experienced in adapting vehicles to accommodate wheelchairs.

Planned reviews are essential because adults' needs change as their condition progresses.

Issues specific to adults with increasing needs are shown below.

See chapters 6 – 9 for further information on seating, assessment and wheelchair features.

| ISSUES | NEEDS | BENEFITS |
|---------------------------------------|--|--|
| Maintaining independence | <ul style="list-style-type: none"> ■ Full assessment ■ Provision of appropriate wheelchair, possibly with 'non-standard' features ■ Consideration of transport and driving issues | <ul style="list-style-type: none"> ■ User independence ■ Helps user accept need to use wheelchair |
| Access difficulties | <ul style="list-style-type: none"> ■ Full assessment and liaison with other appropriate services | <ul style="list-style-type: none"> ■ Enables user to continue with usual activities |
| Acceptance of loss of walking ability | <ul style="list-style-type: none"> ■ Staff sensitivity to this issue ■ Provision of a suitable wheelchair | <ul style="list-style-type: none"> ■ Promotes independence, and assists transition from walking to wheelchair |

1. Harpin P (Second edition – 2003). *Adaptations Manual*, Muscular Dystrophy Campaign ISBN 0 903561 042.

| ISSUES | NEEDS | BENEFITS |
|--|--|--|
| Postural support/comfort | <ul style="list-style-type: none"> ■ Correctly fitting wheelchair ■ Supportive seating | <ul style="list-style-type: none"> ■ User comfort ■ Minimises risk of postural deformities developing or deteriorating |
| Transfers | <ul style="list-style-type: none"> ■ Full assessment of needs ■ Provision of suitable wheelchair/seating with 'non-standard' features if necessary ■ Consideration of driving/transport needs | <ul style="list-style-type: none"> ■ Maximises user independence |
| Additional equipment e.g. powered mobile arm support | <ul style="list-style-type: none"> ■ Full assessment ■ Modifications allowing essential equipment to be carried on wheelchair | <ul style="list-style-type: none"> ■ Maximum possible user independence |

5.5 ADULTS WITH EMERGING NEEDS

For many adults, a wheelchair will become essential at some stage. Most neuromuscular conditions are progressive and, generally, once an ability is lost, it is very unlikely to be regained. Despite the differing rates of progression, the pattern of weakness often follows a predictable course. Weakness in the hip girdle muscles causes a 'waddling' gait. It becomes difficult for the affected individual to walk distances, climb steps, manage uneven surfaces and rise from sitting to standing. The knees can 'give way' when walking, resulting in falls, and the individual finds it extremely difficult – and often impossible – to get up. There is

also a risk of fractures. Even though they are still able to walk, people at this stage of a condition are likely to need assessing for their first wheelchair.

Loss of mobility has a significant psychological effect on most users. Many will be used to working, driving and living independent lives. Maintaining independence through provision of an appropriate wheelchair can help to ease any psychological impact.

There is likely to be some degree of weakness around the shoulder girdle and the impact of this needs to be fully assessed.

FACTORS TO CONSIDER:

- Need for wheelchair outdoors but not indoors
- Possible shoulder girdle weakness, which may make it difficult to self-propel
- Psychological impact of the need to use a wheelchair
- Maintaining independence
- Difficulty rising from sitting to standing
- Difficulty with transfers
- Vehicles – transporting the wheelchair.



5.6 PROVISION

KEY ISSUES TO CONSIDER

Accepting the need for a wheelchair affects people differently. Be sensitive to these psychological issues while emphasising that an appropriate wheelchair will help overcome fatigue and over-exertion, which may be harmful to the muscles.

"My new chair has already made a great difference to my quality of life. I'm able to get the chair into the car, get to the shops independently and collect my children from school."

A 36-year-old man who has Becker muscular dystrophy

Even if initial use is limited, having access to a wheelchair for days out, shopping trips, for example, can enable an adult to continue normal activities while gradually coming to terms with his or her changing mobility needs. Using a wheelchair can also prevent

a 'crisis' situation arising if a fracture is sustained following a fall. The wheelchair will, eventually, be needed more often. Delaying provision of an appropriate wheelchair at this time achieves little and is likely to cause a significant reduction in independence.

A full and detailed assessment will be needed (*see chapter 7*) as well as liaison with the user, carers and relevant professionals. Although there is no definitive research available on the subject at present, it is generally agreed by experts working within the field of neuromuscular conditions that the introduction of postural support into the user's wheelchair prescription should be a proactive process. It should begin when they start to need the wheelchair on a daily basis, even if they are still able to stand and walk for short distances. At this stage the user may be able to maintain an

upright posture against gravity for short periods whilst seated, but over time a kyphotic, asymmetric posture tends to develop as muscles prematurely fatigue. Postural support, such as a contoured back support and cushion, can help the individual return to a symmetrical posture. Provision of an attendant-controlled wheelchair, or a self-propelling wheelchair that cannot be used independently outside, is not acceptable. The possible use of high performance manual wheelchairs, power assist kits or powered wheelchairs should be considered if necessary (see chapter 9). Difficulties with rising from sitting to standing

may be overcome by the use of a powered wheelchair with seat height adjustment.

Consideration will need to be given to how the wheelchair will be put into/taken out of/carried in the user's vehicle. Specialist advice is available from Mobility Centres and/or equipment companies.

Planned reviews are essential because adults' needs change as their condition progresses.

Issues specific to adults with emerging needs are shown below.

See chapters 6 – 9 for more information on seating, assessment and wheelchairs.

| ISSUES | NEEDS | BENEFITS |
|--|---|--|
| Need for wheelchair outside but not inside | <ul style="list-style-type: none"> ■ Full assessment of user's ability to manage any proposed wheelchair outside | <ul style="list-style-type: none"> ■ Ensures user independence |
| Difficulty self-propelling due to shoulder girdle weakness | <ul style="list-style-type: none"> ■ Full assessment of ability to self-propel on a variety of surfaces and slopes/ramps ■ Possible provision of a high performance manual wheelchair, power assist kit or powered wheelchair | <ul style="list-style-type: none"> ■ Enables user to maintain independent mobility |
| Maintaining independence | <ul style="list-style-type: none"> ■ Full assessment ■ Provision of appropriate wheelchair, possibly with non-standard features ■ Consideration of transport and driving issues | <ul style="list-style-type: none"> ■ User independence ■ Helps user accept need for wheelchair |

| ISSUES | NEEDS | BENEFITS |
|--|--|---|
| Psychological impact of the need to use a wheelchair | <ul style="list-style-type: none"> ■ Staff sensitivity ■ Provision of a suitable wheelchair, possibly with non-standard features | <ul style="list-style-type: none"> ■ Promotes independence, assisting transition from walking to wheelchair |
| Difficulty rising from sitting to standing | <ul style="list-style-type: none"> ■ Provision of wheelchair with added features, e.g. full length armrests, increased seat height, powered seat rise | <ul style="list-style-type: none"> ■ Enables user to stand from wheelchair ■ Allows continued walking ■ Assists transfers ■ Promotes independence |
| Transport/driving | <ul style="list-style-type: none"> ■ Full assessment ■ Consideration of how wheelchair will be put in/taken out/carried in the car | <ul style="list-style-type: none"> ■ Enables user to continue living independently |

5.7 SPECIAL CIRCUMSTANCES

During pregnancy, women with neuromuscular conditions who are usually able to walk may find this more difficult or impossible and may need access to a wheelchair.

Full-time wheelchair users may need modifications or an alternative wheelchair during pregnancy, e.g. reclining backrest, elevating leg rests.

It is essential, in all cases, that the wheelchair and postural support not only maintain function, independence and comfort but are also appropriate for the user's lifestyle. The prescription should be tailored to the therapeutic plans of the supervising team and the lifestyle wishes of the user and his or her family.

Provision of appropriate wheelchairs and supportive seating at the correct time can enable adults with neuromuscular conditions to live full and active lives and decrease their dependence on others.

6

PRINCIPLES OF SEATING



INTRODUCTION

Children and adults with progressive neuromuscular disorders may have very specific seating needs and meeting those needs can be challenging for Wheelchair Services.

Wheelchairs were originally designed to transport people from one place to another and now they have evolved to rank among the most important therapeutic and rehabilitative devices^[1]. As technology has advanced, the expectations of many users have risen and the gap between what is available and what is prescribed can often be frustrating. Applying for a first wheelchair can be an emotionally challenging time for a user as they may feel they have reached a significant milestone in the progression of the disease^[2].

Coping with a condition where the goal posts are constantly moving is not easy and there is a degree of evidence that explores the psychosocial impact of progressive neuromuscular disorders upon families^[3]. The progression of neuromuscular conditions can make it difficult to prescribe appropriate seating as frequent appointments may be required. It may also be necessary to ensure a review system is in place to be certain that the prescription delivered in previous months is still appropriate throughout the changing physical parameters of the condition^[4].

1. *Gavin–Dreschnack D (2004). Effects of wheelchair posture on user safety Rehabilitation Nursing Vol. 29 No. 6 pp221-6.*
2. *Farley R, Clark J, Davidson C, Evans G, MacLennan K, Michael S, Morrow M, Thorpe S (2003). What is the evidence for the effectiveness of postural management? International Journal of Therapy and Rehabilitation Vol. 10 No.10 pp449-455.*
3. *Morrow M (2004). Duchenne muscular dystrophy – A biopsychosocial approach Physiotherapy Vol. 90 No. 3 pp 145-150.*
4. *Harpin P (Second edition – 2003). Adaptations Manual, Muscular Dystrophy Campaign ISBN 0 903561 042.*

Twenty-four hour postural management is now an accepted treatment modality of allied health professionals working within the field of neurodisability^[2,5]. Postural management is defined as ‘the use of any technique to minimise postural abnormality and enhance function’^[2]. Therapists assess sitting, lying and standing postures to ensure an individual is able to adopt as symmetrical a posture as possible during

prolonged periods of immobility while still being comfortable, able to function and maintain pressure redistribution techniques. When prescribing any form of postural support it is helpful if the therapist has a sound knowledge of the way the condition progresses in order to facilitate appropriate proactive intervention^[6].

This chapter explores fundamental aspects of appropriate seating and wheelchair prescription.

6.1 OPTIMUM SEATING POSITION

It is generally accepted that there are four main aims which may be considered when assessing an individual’s seating and wheelchair:

1. Achieve the optimal postural position to minimise developing deformity taking account of the effects of gravity.
2. Maintain/enhance functional ability.
3. Comfort and appropriate support, which may vary throughout the day.
4. User acceptance and compliance.

It is important that therapists discuss these aims with a user when assessing the wheelchair prescription, to ensure both the user and therapist have common goals. User compliance is vital to sustain an effective intervention and can usually be achieved when both parties work in partnership^[7]. Sharing information is fundamental to developing an understanding of the challenges that each user will face on a daily basis and will assist the therapist when prescribing specific equipment.

5. Poutney TE, Mulcahey CM, Clarke SM, Green EM (2004). *The Chailey Approach to Postural Management*, second edition Active Design, Birmingham.

6. Bushby K, Bourke J, Bullock R, Eagle M, Gibson M, Quinby J (2005). The multidisciplinary management of Duchenne muscular dystrophy *Current Paediatrics* Vol. 15 pp292-300.

7. Mead J (2000). Patient partnership. *Physiotherapy* Vol. 86 No. 6. pp282-284.

6.2 INTRODUCTION OF POSTURAL SUPPORT

There is currently no definitive research to define the correct time at which postural support should be introduced into the wheelchair prescription of a user with a neuromuscular condition. Expert opinion, however, suggests that it should be a proactive process commencing when the user requires the wheelchair on a daily basis, even though they may still have the ability to stand and walk for short distances. The adage 'prevention is better than cure' is an appropriate inception in this case.

The use of a wheelchair is generally required when proximal muscle weakness is clearly exhibited in frequent falling, difficulty rising

from a seated position and/or an inability to make small postural changes to aid balance when walking over uneven ground or negotiating ramps, slopes and kerbs^[8]. Although the user may be able to maintain an upright posture against gravity for short periods of time while seated, a kypho-scoliotic asymmetric posture tends to develop as muscles prematurely fatigue when the position is maintained for longer periods. Postural support, such as a contoured back support and seat cushion, can help support the individual during postural changes and may also help the user to return to a symmetrical posture^[8].

6.3 PRINCIPLES OF PROMOTING AN APPROPRIATE SITTING POSITION

As sitting is not simply a passive activity, the therapist may work towards ensuring the wheelchair and seating prescription is configured to be as ergonomically sound as possible. It is essential to promote a symmetrical posture and in seating there is a clear role for postural management to enhance musculoskeletal development^[2]. During the growth period, it is important to take account of the fact that deformity will develop more



5. Clark J, Michael S, Morrow M (2004). Wheelchair postural support for young people with progressive neuromuscular disorders. *International Journal of Therapy and Rehabilitation* Vol. 11 No. 8 pp365-373.

readily if the user is exposed to long periods of asymmetric posture as a result of the effect of gravity on weak postural muscles^[9]. Common clinical practice is to work towards a level pelvis in the frontal plane, align the trunk with lateral supports so the head is in midline, and support the elbows and forearms on a tray with arm supports^[8].

Two key principles underpin the achievement of an optimal sitting position:

1. Maintenance of an appropriate position of the pelvic girdle.

2. Optimum support for the whole body.

It should be noted that these principles are guidelines and there may be exceptions to the rule that an experienced practitioner may change to assist a specific user's posture.

1. MAINTENANCE OF AN APPROPRIATE POSITION OF THE PELVIC GIRDLE

Generally, the pelvic girdle is best supported in the upright, neutral position, without either a posterior tilt that results in 'sacral sitting' or an anterior tilt that adversely increases the lumbar curve. It should be noted that some literature does advocate a degree of anterior tilt that can be helpful in locking the facet joints to prevent lateral curvature, however this approach cannot

be substantiated with a sound evidence base^[10]. In some cases, a very small amount of posterior pelvic tilt can be more comfortable if maintenance of a neutral pelvis is difficult for the user to achieve or maintain for long periods of time.

Fig 1 Pelvic obliquity of spine with scoliosis

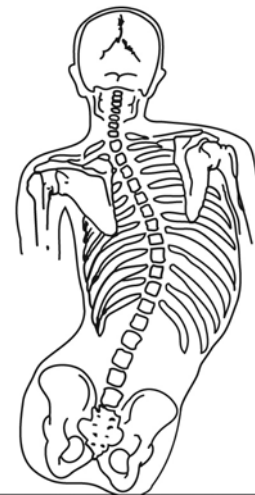

Fig 2 Neutral pelvis

Fig 3 Posterior tilt

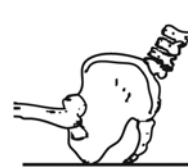

Fig 4 Neutral pelvis

Fig 5 Anterior tilt



9. Engstrom B (1993). Ergonomics, wheelchairs and positioning, first edition Bromma Tryck AB, Sweden.

10. Meigen I, Kiyoshi M, Kozo H, Toshiyuki F, Naoichi C (2003). Practical problems and management of seating in Duchenne muscular dystrophy. Arch Phys Med Rehabil Vol. 84 pp818–824.

2. OPTIMUM SUPPORT FOR THE WHOLE BODY

Adaptive seating can maintain symmetrical posture but it can also cause deformity if incorrectly fitted^[9]. Posture could also be adversely affected if the user is not correctly seated within the wheelchair^[8]. Consider the following:

- A) Seat width
- B) Seat depth
- C) Seat surface
- D) Seat height
- E) Leg/foot support
- F) Arm support
- G) Back support
- H) Head support
- I) Wheel position
- J) Position and type of joystick

A) SEAT WIDTH

To promote optimum support, it is best if the seat is wide enough for comfort and yet a 'neat' enough fit to ensure the pelvis is stabilised. This ensures that the arm supports are close enough to the user to eliminate the need to lean sideways to gain support from them and that the wheels on a self-propelling chair are in an optimum position for pushing. If the seat is too wide the user not only has a need to lean sideways but also tends to sit more to one side than the other, which may cause a pelvic obliquity^[4].

If sidepads are used to reduce the seat width, the pads of the armrests should be extended inwards (inboarded) over the sidepads, ensuring that the user's arms are supported. If the armpads cannot be extended inwards because the back or lateral supports are in the way, customised armpads may be required.

Pelvic obliquity can result from the seat being too wide

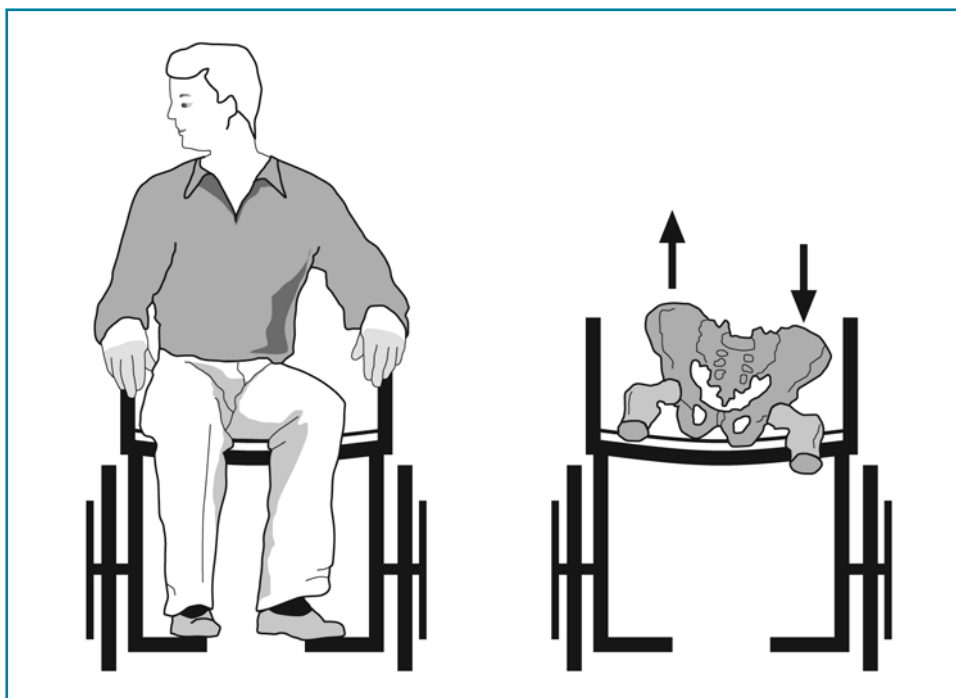

B) SEAT DEPTH

The seat depth is crucial to ensure that the spine is adequately supported while at the same time maintaining the pelvis in an appropriate position. It is usually best if the seat depth is as long as possible to give maximum sitting area for support, pressure redistribution and stability without impacting on the back of the leg, but still allowing the user full contact with the back support. The seat depth may be influenced by:

- femur length
- pelvic orientation
- hamstring contractures
- use of orthoses
- pressure distribution
- hanger angles.

It is generally accepted that the growth rate of a child or a young person is 1:3 width:height/length so, if possible, this growth potential should be built into the seat depth. This will promote a more efficient use of the wheelchair over a greater length of time.

C) SEAT SURFACE

An appropriate surface will support the weight-bearing part of the pelvis (the ischial tuberosities) when the user is sitting. It should contour to the user's pelvis to provide pressure redistribution, support and comfort. Users with a neuromuscular condition may be unable independently to change position so care should be taken with cushions (such as one-section air cushions and those with low viscosity) that could allow a pelvic obliquity to develop if left unsupervised.

Ischial tuberosities 'bed' in to seat support

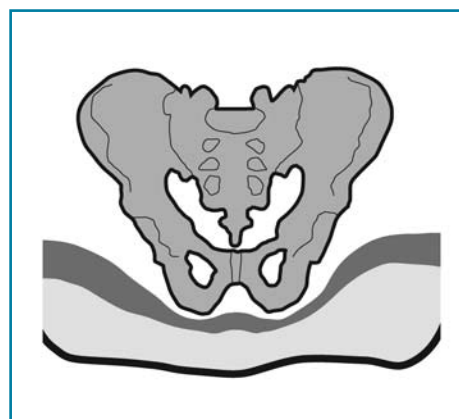

If using cushions with visco-elastic foams (also known as 'memory foams'), consider the weight of the user. Heavier users may compress the foam in the cushion to an extent that it causes a significant increase of pressure under the bony prominences.

Users who are very slight and have bony prominences can sometimes displace the gel in certain cushions, rendering it unsatisfactory.

The seat should be firm enough to prevent downward pressures, which can cause distortion, but flexible enough to allow the user to 'bed' into it, dissipating pressure throughout the seated surface. Cushions that do not have a 'memory' are sometimes the preferred option in these cases.

It is helpful if the seat canvas is correctly tensioned, as this will prevent sagging in the middle producing a hammock effect. An incorrectly tensioned canvas will not provide a firm support for a cushion, if required, and can cause the user to sit with an asymmetric posture encouraging a pelvic obliquity.

D) SEAT HEIGHT

The height of the seat with appropriate cushioning is very important when considering the type of transfer the user will be doing both now and in the future. If a non-standard seat height (higher or lower) is required, it is advisable to discuss the environmental impact with the user and carers as it may affect desk heights, tables, clearance under wash basins etc. Many high performance manual wheelchairs have seat height options. Powered seat risers are also available and may be retro-fitted on some powered wheelchairs.

E) LEG/FOOT SUPPORTS

Due to the progression of these conditions, the typical toe-walking gait and often long periods spent sitting, there is a tendency to develop flexion and abduction contractures of the hips and flexion contractures of the knees. Tightness of the gastrocnemius muscle (often referred to as achilles tendon tightening) also occurs and if left unmanaged, can progress to cause a severe planter flexion/inversion deformity of the foot.

Provision of appropriate foot supports is an essential part of the overall management of leg and foot position.



Most people with neuromuscular conditions prefer to sit upright in their wheelchair (unless using the recline or tilt-in-space functions in order to relax, relieve fatigued muscle groups or redistribute pressure) as this enables them to use their limited ability to reach forward and to maintain head control. To provide stability and maintain position, it may be useful to maintain knee joint position close to 90 degrees wherever possible.

Depending upon knee joint position, it may be advantageous to support the ankle joint at an angle of 90 degrees but this may not be achievable if the user already has shortening of the gastrocnemius muscle. In this case an angle-adjustable foot support may be required to accommodate this. The further forward the feet are in relation to the body, the more there is a tendency for posterior pelvic tilt and loss of the normal lumbar lordosis. However, some users may still prefer to have their feet supported slightly in front of them, particularly if there is already adaptive shortening in the soft tissues of the hip joints and/or spine. This position may also be required to accommodate large front castors or provide ground clearance of foot supports in users with longer legs. Note that many manufacturers recommend a minimum of five centimetres ground clearance under the foot support.

Adequate foot supports are essential for optimal lower limb positioning. Foot supports that are too high reduce the weightbearing area of the thigh,

encourage hip and knee flexion contractures and affect the stability of the pelvis and spine. Foot supports that are too low or missing will increase the pressure on the user's thighs, may restrict lower leg circulation and may contribute to nerve compression as well as compromising overall posture. Foot supports that are too low also encourage the development of a plantar flexion/inversion deformity of the foot. Foot supports that are incorrectly angled can cause pressure ulcers and callus formation particularly under the base of the fifth metatarsal.

Some users find it beneficial to have an extended foot support, enabling weight distribution over a greater area. However, this can increase the overall length of the chair and consideration of the turning circle and transport issues may be required. If foot deformities are already severe, a large padded footboard may be the only option. Ensure these can be removed if necessary to allow the foot hangers to swing away.

The height and angle of foot supports require careful monitoring on a regular basis, especially for children as they grow.

Once foot deformities have developed they can be very difficult to manage and cause problems with pain and footwear.

Surgical correction may be required so liaison with the user's medical team is recommended.

Optimum foot support is only part of the overall foot management. The user's physiotherapist can advise on stretches, passive movements, splints and standing frames, if appropriate^[11].

It is important to remember that footplates can be vulnerable and often take knocks from doorframes and other objects. Consider durability issues when prescribing appropriate foot supports. If future adjustment is anticipated, providing a multi-adjustable footplate from the start may be cost effective and is likely to cause less frustration to the user.

Independent powered leg supports may be beneficial to users who have poor muscle power to enable them to change the position of their legs independently.

F) ARM SUPPORT

These should be at the correct height to support the user's arms with the shoulders level and not elevated. The elbows should be supported in a comfortable position. Always measure for arm support height with the cushion in place to take into account any cushion compression. Arm supports with infinite adjustment are best for small children, as those with increments of one inch do not always allow

11. *Eagle M (2002)*. Report on the Muscular Dystrophy Campaign workshop: exercise in neuromuscular diseases. *Neuromuscular Disorders* Vol. 12 No. 10 pp 975–983.

appropriate positioning. Full and partial trays can also be used to support the arms, particularly if the user likes to lean forward.

If subluxation of the shoulder has occurred due to muscle weakness, the arm support may need to be slightly higher than standard to provide more support for both the shoulder joint and shoulder girdle. Use of a tray may also help alleviate stress on weak shoulder girdle, neck and upper spine muscles.

The length of the arm supports can affect standing transfers and some users may require non-standard or custom-made arm pads.

Ensure that the trunk is being supported by appropriate lateral trunk supports, and not by excessive forces through the arm supports or tray as this not only increases stress on the user's upper limbs and shoulder girdle, but could also encourage undue forces through parts of the wheelchair not designed to withstand them.

G) BACK SUPPORT

The back support should be adequate for the user with the seat cushion in place. If a user has a self-propelling wheelchair, the back support and push handles (if supplied) should not interfere with the pushing action. It may also be advisable to check that the seat cushion does not interfere with the wheel position

as this can cause friction during propulsion. Back supports should be assessed prior to provision to determine if they will adversely affect the way in which the user propels the wheelchair.

A powered wheelchair user is likely to benefit from support to the level of the shoulders. Above this level there is a natural lordosis of the cervical spine so higher back supports will have no effect on head and neck position with the wheelchair upright. They may be effective if the wheelchair has tilt-in-space or recline functions but an appropriate head support may also be required.

Contoured back supports may not be suitable for users who utilise a powered recline function within their wheelchair because of the alterations to position that take place when the back support reclines and the seat/back angle increases. The recline function can be extremely beneficial in certain cases but careful assessment by an experienced practitioner is required.

In order to achieve maximum conformity (i.e. maximum contact between user's spine and backrest), while maintaining and supporting, where possible, normal spinal curves, it may be advantageous to carry out an individual assessment of the user's back. Where the posture is too kyphotic in the lumbar area

the use of some sacral/pelvic support to encourage spinal extension has been found to be the best practice rather than using lumbar pads as previously advocated in some literature. Reviewing the seat angle may also improve spinal extension.

The angle of the back support is critical for ensuring optimal balance, head control and maximum arm function.

The 'lie to stand' feature on advanced power chairs can help the user lie down to rest. It also assists therapeutic interventions such as passive movements and stretches and is helpful to facilitate the application of a hoist sling. Lying down after undertaking a session in the standing position can assist with repositioning within the wheelchair to achieve the best sitting posture and ensure clothes have been correctly readjusted. This is particularly helpful for users with little active movement, but again, careful consideration of an appropriate backrest will be required.

H) HEAD SUPPORT

It is good practice to supply a head support for anyone with poor head control or a user with tilt and/or recline functions on their wheelchair. Any user who travels in a vehicle in their wheelchair should ideally use a head support to reduce the risk of whiplash injury. Careful consideration should be given to all the risks involved and it should be noted that the functional position of the head support may be different from that required for transportation.



Head supports which support under the jaw line are available but these can restrict speech, eating and jaw movements. Care should be taken when setting up a head support to ensure it is in the optimum position for the user. This is particularly important if the individual has swallowing difficulties.

I) WHEEL POSITION ON A SELF-PROPELLING WHEELCHAIR

The position and combination of wheel size, tyre type and hand rim on a self-propelling wheelchair requires careful consideration. Undue movement requires an excess of energy expenditure and can increase the risk of repetitive strain injury. Larger wheels may be more ergonomically effective as less muscle power is required to propel the wheelchair. Wheelchairs with adjustable wheel positions offer flexibility as the user's needs and posture change.

J) POSITION AND TYPE OF JOYSTICK

Correct positioning of the joystick can minimise head and neck contractures. If the joystick is positioned too far to one side, the user will naturally lean towards the opposite side to maintain balance. The best position for the joystick is in line with the armrest or, if possible, nearer mid-line. Some manufacturers advocate a centrally mounted joystick to ensure symmetry. These can be mounted on a tray or with a flexible arm but can cause difficulty fitting under tables.

Many types of joystick are available and all should be thoroughly explored, particularly regarding sensitivity to touch. According to Pellegrini et al (2004) adults with Duchenne muscular dystrophy gradually lose their

ability to drive using a conventional joystick but can use mini-joysticks, isometric mini-joysticks, finger joysticks or pads. This study also suggests the individual can use the chin, mouth, or alternative fingers, to control the wheelchair. For many older adults, key pinch is the only significant strength left in the upper limb, which can still be utilised to drive a powered wheelchair in the advanced stages of a neuromuscular condition^[12].

If a user has upper limb weakness and uses a joystick to tilt or recline their wheelchair, their arm can slip back and they may not have sufficient muscle power to move against gravity to re-access the joystick to return to the upright position. An elbow cup or a head switch may be helpful in this situation.

6.4 COMFORT AND PRESSURE REDISTRIBUTION

It may be beneficial to consider carefully comfort and pressure redistribution during a wheelchair and seating assessment. The ischial tuberosities, sacral coccygeal area, greater and lesser trochanters and intertrochanteric crests are subject to excessive pressures when the user is in the sitting position^[13]. These high pressures will initially cause discomfort but can also lead

to occlusion of the capillaries, which may result in a breakdown of the soft tissue over these bony prominences. Many users with a neuromuscular condition are unable to change position independently and will therefore rely on technology to assist with pressure redistribution in order to maintain a comfortable and safe posture throughout the day^[14].

12. Pellegrini N, Guillon B, Prigent H, Pellegrini M, Orlikovski D, Raphael JC, Lofaso F (2004). Optimisation of power wheelchair control for users with severe Duchenne muscular dystrophy. Vol. 14 No. 5 pp297-300.

13. Peterson MJ, Adkins HV (1982). Measurement and redistribution of excessive pressures during wheelchair seating. Vol. 62 Ch 7 pp990-4.

14. Lacoste M, Weiss-Lambrou R, Allard M, Dansereau J (2003). Powered tilt/recline systems: why and how are they used? Assistive Technology Vol. 15 No. 1 pp 58-68.

Asymmetrical postures can increase sacral seating pressure and asymmetrical loading of the ischial tuberosities. This can be uncomfortable and also cause pressure ulcers. For users who have had spinal fusion surgery, the loss of physiological lordosis can also contribute to increased pressure under the sacrococcygeum^[15].

It is likely that the most effective way to redistribute pressure is by constantly changing position and readjusting the load, but users with a neuromuscular condition will be unable to do this independently because of muscle weakness. The prescription of wheelchair cushions therefore requires thorough assessment.

Many wheelchair cushions can assist with pressure redistribution. Cushions are only one part of the equation, however, and the tilt-in-space and recline functions on an advanced powered wheelchair can also reduce the pressure under the sacrum and ischial tuberosities^[16]. Pressure mapping devices may be helpful when undertaking an assessment.

There is no doubt that a wheelchair with a tilt-in-space function can substantially help redistribute pressure. There is uncertainty, however, about the best tilt angle and the length of time the user should stay in a tilted position. These factors are likely to vary from person to person and will depend on the degree of asymmetrical posture, fixed deformity and surgical intervention. It is generally accepted that the greater the degree of tilt, the greater the pressure redistribution under the sacrum and ischial tuberosities and femurs. However, the increase in pressure over the spinous processes and scapulae during tilt may require monitoring.

Movement between the vertebrae is no longer possible for users who have had spinal fusion surgery. Many users report a build-up of pressure in their lumbar region as the day goes by, and tilting back is likely to help alleviate this feeling.

Much deformity is caused by the effects of gravity on the body where muscle power cannot oppose these forces. Assisting users with neuromuscular disorders to change position in order to counter these effects is imperative.

15. Drummond D, Breed AL, Narechania R (1985). Relationship of spine deformity and pelvic obliquity on sitting pressure redistributions and decubitus ulceration. *Journal of Paediatric Orthopaedics* Vol. 5 Ch 4 pp396–402.

16. Pellow TR (1999). A comparison of interface pressure readings to wheelchair cushions and positioning: a pilot study. *Canadian Journal of Occupational Therapy* Vol. 66 Ch 3 pp140-9.

INTRODUCTION

As muscle weakness usually commences proximally in the trunk region – the core of good posture – it may be advisable to consider supportive seating as soon as the user requires a wheelchair, albeit for long distances.

There are no physical markers to accurately predict how quickly a condition will progress, therefore, it is prudent to aim to work in a proactive manner. Proximal support enables effective use of the upper limbs and maintenance of head control. Even if a user only requires the use of a wheelchair to travel long distances, appropriate seating can help to maintain a symmetrical upright posture.

Many wheelchair dependent users are extremely sensitive to their seating and are likely to be anxious about change, fearing a loss of independent function. The views of the user should be considered if any changes are planned. It is usually more acceptable to make small incremental changes to seating over a period of time, than many changes all within the same appointment. If a user is currently able to manage a task, even a small change in position can disrupt the fine-tuning of the balance mechanism rendering the task impossible (playing a games console, for example, or controlling a joystick). It can be arduous for the user consciously to alter their balance, particularly if they have limited ability. Good communication at all stages of the assessment and fitting process is essential.

Many products can help wheelchair users adopt a supportive sitting posture, however, the user's comfort, function and posture in the wheelchair are what is important, not the seating products which achieve this. Many manufacturers offer similar products and the assessor may utilise a variety of products to achieve the most appropriate position. If a user cannot move independently or has difficulty changing position, it is essential that the sitting position does not encourage development of a fixed deformity.



7.1 PHYSICAL EXAMINATION GUIDANCE

Ask the user to sit on a flat surface with feet placed firmly on the floor. If possible, remove sufficient clothing to observe the trunk, pelvis and feet, but be aware of dignity issues. Mark the bony prominences on the back (e.g. the angle of the scapulae, sacro-iliac joints and the spinous processes). Note that the spinous processes may have been removed if the user has had spinal fusion surgery.

Asymmetry is often evident, even after a few minutes. Many individuals are able to adopt an upright symmetrical posture when prompted but would be unable to maintain this posture over time due to premature muscle fatigue.

Document the posture with anterior, posterior and lateral photographs or sketches. Check that the user can correct the sitting position once moved outside the base of support and note whether they need to use trunk and head movements to do so. Observe the extent and direction of any pelvic obliquity. If the user has a significant pelvic obliquity, check whether the pelvis can be levelled by placing a build-up under the lower side. If a user has a fixed pelvic obliquity, investigate whether the loading under the lower side of the pelvis is a problem. Pressure mapping may be advantageous in this situation.

Some users who have undergone surgical intervention, such as spinal fusion, may have a fixed pelvis. Discuss this at the start

of the assessment to clarify the degree of possible correction.

Observe the position of the hips. The iliotibial band is often shortened in users with neuromuscular conditions and is displayed as abduction and lateral rotation of the hip joints. Check whether the hips can be brought to neutral ad/abduction by placement of the lower limb with adductor support within the cushion or lateral thigh supports if the abduction deformity presents to a greater degree.

Passively dorsiflex the ankle joints to determine whether the feet can reach and maintain the plantar grade position.

Observe the extent and direction of any asymmetry in the position of the spine, shoulders and head. Assess whether a three-point force system, applied through lateral supports, would help to maintain trunk position and if so, where the lateral supports should be positioned. Take anthropometric measurements with a steel tape measure as these are generally more accurate.

Check the effect of the seating intervention on the user's balance and upper limb function. Look at the new position of the trunk and head, along with postural alignment and transverse plane rotation of the pelvic/shoulder girdles. Ensure rib cage expansion and diaphragmatic respiration are not impaired by lateral supports or harnessing.

It is best to examine upper limb function with the user seated in a wheelchair. Check whether upper limbs can still be used for functional activities such as eating, drinking, driving a powered wheelchair, operating a keyboard or accessing other forms of electronic technology. Some users utilise 'trick' movements to enhance function (for example, 'walking' the arm up the side of

the wheelchair when it has fallen off the arm support). Consider upper limb ability when examining the recline/tilt-in-space functions of the wheelchair. Assess the user's ability to control the joystick (*see chapter 6*).

It is likely that the user will take some time to adapt to any new position so regular reviews by an experienced professional are generally recommended.

7.2 ASSESSMENT CONSIDERATIONS

SEAT BASE

A cushion with pressure redistributing qualities and some shaping may help a user maintain the pelvic position. The amount of support required will vary.

Pelvic obliquity build-ups and lateral thigh supports can often be incorporated into a contoured cushion. The user's pelvis should fit the 'bowl' of the cushion without 'bottoming out'.

If substantial external lateral thigh supports are needed, these can be mounted to the wheelchair footplate hanger brackets. If appropriate, ensure the user can still use a bottle for toileting. Removable or swing-away supports may sometimes be necessary.

If a user has a severe, fixed pelvic obliquity that cannot be accommodated in a modular cushion, consideration may be given to the provision of an individually contoured seat base.

Cushions can be placed directly onto the standard wheelchair seat if the upholstery is correctly tensioned and the seat surface will not permit slippage of the cushion. A 'dropped' interface board can be used to help stabilise a cushion in a wheelchair and ensures the user is not raised up excessively.

BACK SUPPORT

No/mild/correctable scoliosis

Many users in the early stages of their neuromuscular condition tend to adopt a posture where the weight is carried through one side of the pelvis with lateral flexion of the neck. A firm back support which maintains pelvic position and the lumbar curve enables the user to sit in a more upright posture.

If there is evidence of a scoliosis, alert the user's consultant. Early intervention is vital in spinal care and a local specialist centre can monitor the spine and offer surgery, if appropriate, at the right time.

Where a scoliosis is correctable, it may be beneficial to configure lateral supports to apply a three-point support system to the trunk. To assist with moving and handling activities it is usually beneficial for at least one of the lateral supports to be removable or swing-away.

Severe/fixed scoliosis

A multidisciplinary approach to the treatment and management of neuromuscular conditions means that there are fewer wheelchair users with a severe fixed scoliosis than, for example, ten years ago. However, if a user does portray a difficult spinal posture, an individually contoured backrest is usually found to support the trunk best. This should normally be used when it is not possible to achieve independent sitting balance and the 3D posture of the spine cannot be accommodated within standard back supports. A contoured backrest can 'fix' a user in an undesirable position and should, therefore, be used with care.

Post-spinal fusion

The spinal configuration of users who have had spinal fusion surgery is largely fixed and cannot be changed by seating. Nevertheless, correct seating can help a user maintain head balance and prevent further deformity. Although a back support can give the user a more upright posture and improve frontal alignment, it can also unbalance them and may cause worsening of transverse plane rotation of the pelvic and shoulder girdles. Trying to establish a neutral pelvis can cause rotation in the shoulder girdle. It is often

best to distribute any corrective seating throughout the whole of the trunk rather than aiming to do this just at the pelvis as this can worsen the 'corkscrew effect'.

FOOT SUPPORT

The foot should be supported, if possible, along its full length on the wheelchair foot support. This will reduce pressure, discourage deformity, and may help with pain management if this is a difficulty.

Users should be encouraged to wear supportive footwear, even if they are wheelchair dependent. Many users successfully use ankle foot orthoses (AFOs) and these should be encouraged when appropriate. Those users without AFOs should have support for their feet in as neutral a position as they can tolerate. Ankle straps and/or angle adjustable footplates can help with this. Angle adjustable footplates and/or extended footplates may be helpful for those users who have a shortening of the gastrocnemius muscle causing tightness in the ankle joint. Try to ensure that there is weight-bearing through the whole foot. If a plantar flexion deformity is fixed, minimal, small wedges fitted inside the shoe heel may help.

Intolerance of footwear is often related to excessive localised pressure. Red marks and callus formations can sometimes occur on the lateral border of the foot. An orthotist or podiatrist can help to address any footwear tolerance problems. Foot pain cannot always be controlled by orthoses and/or adapted footplates, and a referral to a consultant or pain clinic may be necessary.

Investigate the effects of a modified foot support on the user's environment as it can sometimes restrict castor operation, kerb climbing and accessibility as well as increasing the length of the wheelchair.

HARNESING

A pelvic harness can help maintain the pelvis in a neutral position. A chest harness may help a user who is unable to correct his or her sitting position, when moved outside the base of support. Chest harnesses are particularly useful for users with poor trunk control when out of doors. A seat tilt can often prevent a user falling forwards but is not a practical position in which to operate a wheelchair as vision may be constrained.

A harness that extends over the shoulders and crosses at the front distributes support and is generally preferred by users. If excessive pressure is still a problem, placing a padded sleeve over the shoulder straps can help. Many users say this type of harness prevents them falling forwards when travelling downhill and being transported in their wheelchair. Many users find a harness improves their confidence and this can help maintain independent wheelchair function outdoors.

Harnesses should not be provided or used routinely and it is advisable to check the impact on respiratory function prior to fitting.

ORIENTATION OF SEATING

Ensure the user is supported in a position that allows him or her to function and maintain posture using the least amount of energy.

Users who inadvertently lean forward may have to recline their backrest slightly and/or place a wedge under the seat cushion to tilt back a few degrees. This not only prevents falling forwards but may also reduce the need for support at the front of the chest. Many users benefit from a wheelchair with a powered seat tilt that can be adjusted. Tilting backwards regularly throughout the day helps redistribute the loading from under the pelvis onto other areas of the body. It stretches the spine out from a kyphotic posture adopted during a prolonged period of upright sitting, and can also relieve muscular related back pain.

HEAD SUPPORT

While users with neuromuscular conditions can appear to have good head control when sitting in an upright position, this can disappear if they are placed in even a slightly tilted position. Assess the user in the wheelchair over a range of terrains, such as slopes, uneven ground, climbing kerbs etc. Be aware that many users with a neuromuscular condition can tire during the day and this is also likely to affect their head control. Some form of head support is usually found to be beneficial from an early stage. Unobtrusive head supports are available and should be fully discussed with the user.

Weakness in the neck is likely to increase as the condition progresses, and the user may then need a more supportive headrest.

Any user who sits in his or her wheelchair while travelling in a vehicle is advised to use a suitable headrest (*see chapter 10*).

ARM SUPPORT

The arm support should be close to the user's body and at the correct height to support the arm. Some users with significant upper limb weakness may need slightly higher arm supports to facilitate 'trick' movements. Height adjustable armrests can quickly and easily accommodate changes in cushion, posture or function.

If the user's arm falls off the arm support, a foam 'ladder' added to the outside of an armrest can help a user 'walk' his or her hand up the side of the wheelchair back to the

arm support. Any arm support pad should be wide enough to support the forearm. If a user has no functional movement of the upper limbs, velcro straps can help maintain the arms on the supports in a position to access the joystick.

Some users like to use a tray to facilitate upper limb function and relieve muscle fatigue of the shoulders and upper trunk. Check whether the tray will be wide enough to support the elbows. The tray should be easily removable for transfers and to allow the user to sit at a table with family and friends if required.

CONCLUSION

Wheelchair and seating assessments for any individual can be complex and this is felt to be particularly true in conditions where progression is inevitable. Muscle weakness and fixed deformity may represent difficult challenges to both the assessor and the user and collaboration is a necessary element in any assessment. For children, this is further complicated by the growth potential and it is hoped that these guidance notes will assist with appropriate decision-making in terms of the wheelchair and seating prescription.

References

Morrow M, Michael S, Clark J (2002). A guide to seating for bioengineers, physiotherapists, occupational therapists and rehabilitation engineers, and interested parents.
www.gla.ac.uk/centres/muscle/dmd_seating.htm#guide

8

SEATING AND POSTURE ISSUES – POSSIBLE SOLUTIONS

This chapter includes additional information for professionals who prescribe wheelchairs, about the needs of users with neuromuscular conditions.

It should be read in conjunction with chapters 6 and 7 which detail the clinical reasoning for the solutions suggested here.

Dealers and representatives of assistive technology companies who provide equipment demonstrations and/or help with provision should be made aware of the clinical issues in the long-term management of neuromuscular conditions. Collaboration between the assistive technology provider and the therapist can produce the best outcome for a user.



PELVIS AND HIPS

POSTURAL ISSUE AETIOLOGY,
EFFECTS AND ASSESSMENT

WHEELCHAIR AND SEATING EQUIPMENT

Anterior pelvic tilt (APT)

Aetiology:

- Tight hip flexors
- Weak muscles
- User finding it a stable position.

Effects:

APT causes an increase in the lumbar lordosis and reduces the functional reach of a user (more so than a posterior pelvic tilt).



Assessment:

By height discrepancy, with ASISs lower than PSISs.

Regularly check the position of the pelvis so any changes can be quickly detected.

Management will depend on whether the APT is fixed or correctable.

The following are possible solutions and either one, or a combination, may help.

Solutions:

1. A good quality, tension adjustable back canvas with many narrow straps which can be adjusted to encourage 'softening' of excessive lordosis. A standard back canvas is inappropriate.
2. Create a rearward sloping seat and carefully set up the back angle to reduce the tendency to lumbar lordosis.
3. Using an adapted tray to form an anterior support for the trunk is often very effective and functional for the user.
4. Padded pelvic positioning accessories (i.e. belts, straps and harnesses) can be used but need to be tight to be effective and are, therefore, not always well tolerated.
5. Open the hip angle by altering the seat angle or using the recline function. Be careful not to cause the pelvis to slide forwards.
6. Tilt-in-space is very beneficial.

Modifications to posture and position are best done in small incremental changes as these allow the user to adapt to them physiologically.

PELVIS AND HIPS

POSTURAL ISSUE AETIOLOGY,
EFFECTS AND ASSESSMENT

WHEELCHAIR AND SEATING EQUIPMENT

Pelvic obliquity

Aetiology:

- Muscle weakness (including head and neck)
- Effects of gravity
- Asymmetric postures
- Poor seating.



Effects:

- Asymmetrical posture and detrimental effect on sitting balance
- Asymmetrical weight bearing, increasing risk of tissue breakdown
- Physiological implications include restricted respiration, digestion.

Assessment:

Palpate the ASISs and check for a height discrepancy between them. Record any obliquity and associated spinal scoliosis so it can be monitored. With any obliquity there is nearly always a compensatory scoliosis. To assess a scoliosis, palpate the spinous processes along the length of the spine. If taking photographs, it may help to stick coloured paper dots over the processes.

It is also worth checking for rotation which will display as one ASIS being posterior/anterior to the other.

Regularly check the position of the pelvis so any changes can be quickly detected.

Management will depend on whether the pelvic obliquity is fixed or correctable.

Contributing factors may be:

- Seat is too wide
- Arm supports are set too far apart or too low worn, sagging seat upholstery and/or unsuitable foam cushion
- Incorrect orientation/use of a specialist cushion (unstable laterally)
- Insufficient trunk support, causing user to lean more to one armrest for additional support
- Unilateral joystick.

Solutions:

1. Ensure correct seat dimensions, arm support positioning etc.
2. Ensure a level base of support for the cushion.
3. Provide appropriate cushion and ensure correct usage.
4. If obliquity is flexible, use a specialist cushion to correct.
5. If the obliquity is fixed, compensate by building up the high side and/or lowering the low side to even out contact area throughout the cushion.
6. Ensure sufficient trunk support for level of disability and prescribe proactively.
7. Consider alternative position for joystick/specialist control.

PELVIS AND HIPS

POSTURAL ISSUE AETIOLOGY,
EFFECTS AND ASSESSMENT

WHEELCHAIR AND SEATING EQUIPMENT

Pelvic rotation

Aetiology:



The rotational deformity of the pelvis originates from the spine. When attempting to correct at the pelvis ensure you are not shifting the problem up to, for example, the shoulder girdle.

Effect:

Apparent discrepancy between leg lengths due to pelvic rotation.

Assessment:

Rotation can be assessed by palpating the ASISs. Rotation is indicated when one ASIS is posterior/anterior to the other. A different degree of rotation may be seen at the shoulder girdle and should also be assessed.

Regularly check for any spinal/pelvic rotation and deal with it quickly before it becomes fixed.

Management will depend on whether the pelvic rotation is fixed or flexible.

Using contoured cushions and back supports at an early stage reminds the user to stay in a neutral/symmetrical sitting position.

Wind-sweeping of femurs may also occur.

Monitor and provide the necessary support to prevent abnormal compensatory postures being adopted by the user to gain the desired trunk stability.

Solutions:

1. Check dimensions of chair and components. A chair that is too wide, for example, can facilitate pelvic rotation.
2. Contoured cushions with good leg troughs.
3. Appropriate lower back support is preferable to a canvas back which may mould to the rotated pelvis.
4. Padded belts.
5. Sub-ASIS bars.
6. Other hip stabilising devices.
7. Appropriate trunk support (see aetiology).

HIPS, KNEES AND FEET

POSTURAL ISSUE AETIOLOGY,
EFFECTS AND ASSESSMENT

WHEELCHAIR AND SEATING EQUIPMENT

Misalignment of femurs

Aetiology:

Wind-sweeping of thighs often associated with pelvic/spinal rotation obliquity or hips abducted and externally rotated.

Assessment:

In a supine position. Taking photographs is recommended as measurements can be complex for this posture.

Solutions:

1. Hip and thigh guides are helpful.
2. Adductor/abductor wedges on a cushion/system.
3. Contoured cushion that provides leg troughs.
4. Padded leg straps.

Flexion contractures at hips occur at an early stage, even in users who are ambulant

Aetiology:

- Muscle weakness
- Loss of elastin in muscle fibre
- Shortened hamstrings
- Weak proximal muscles.

Assessment:

With goniometer.

Prevention of hip contractures are not the principal concern for users – often with an anterior tilted pelvis – who are more stable sitting with a closed hip angle (i.e. less than 90 degrees between back and seat).

Therapeutic standing and use of the recline function on a wheelchair can help maintain a range of movement in the hip. Physiotherapy is also vital.

Consider bone density when prescribing a wheelchair with a standing function. Tests may be needed before using such a wheelchair, particularly if the user has not been weightbearing for some time or has used/is currently using steroids.

Flexion contractures at hips occur at an early stage, even in users who are ambulant

Aetiology:

- Muscle weakness
- Loss of elastin in muscle fibre
- Shortened hamstrings
- Weak proximal muscles.

Assessment:

With goniometer.



Regular monitoring of a user's range of movement can help to identify flexion contractures at an early stage.

Any management programme should include physiotherapy. Surgery may be required in some cases.

Solutions/management

1. Determine whether stretching is appropriate with articulating leg supports (with leg length compensation).
2. If stretching is not appropriate, select appropriate hanger angle for the range of movement e.g. 70, 85 or 90 degrees. This might necessitate a change of wheelchair.
3. Some footplates can be adjusted forwards and aft (anterior/posterior).
4. Examine the effect of heel and calf straps. Note the pressure exerted by the straps on soft tissues and check for sores/ulcers.
5. To avoid compromising posture, consider cushions with calf recesses or customising a cushion. Otherwise, seat depth will need to be shortened which will reduce the surface area of the cushion/seat in contact with the calves and increase the risk of skin breakdown. Pressure needs should be re-evaluated.

HIPS, KNEES AND FEET

POSTURAL ISSUE AETIOLOGY,
EFFECTS AND ASSESSMENT

WHEELCHAIR AND SEATING EQUIPMENT

Plantar flexion with or without inversion of feet and ankles



Solutions:

1. Angle-adjustable footplates (anterior/posterior and medial/lateral).
2. Correct size/shape footplates.
3. Padded foot box may be needed to protect feet.
4. Ankle huggers.
5. Check user does not place heel on top of heel strap so positioning the ankle in plantar flexion.

Consider the impact of the above on transfers and independence.

Discomfort and pressure issues

Most users spend many hours in their wheelchairs. They have full sensation but are often unable to change position independently or effectively. A suitable high-pressure redistribution cushion used with the tilt-in-space function can promote skin integrity and help users independently maintain comfort.

SPINE

Flexion contractures at hips occur at an early stage, even in users who are ambulant

Aetiology:

- Muscle weakness
- Seeking external sources of support
- Activity based.

Assessment:

Photography.



It is impossible to prevent scoliosis through wheelchair seating alone. Lateral support via thoracics/thoracic pads/laterals will assist, but the condition should be managed by a multidisciplinary team. Stay in regular contact with this team to ascertain what management strategy they propose (e.g. spinal jackets, surgery), as this will significantly influence the wheelchair and seating prescription.

Some users find harnesses give them more confidence and trunk stability when they are out and about, particularly in vehicles or when negotiating uneven ground, slopes and ramps.

Scoliosis can be managed in the early stages with 2-point, usually symmetrical, contact. If the condition is more advanced it may be necessary to use 3-point contact (see chapter 6). Check for pressure areas and add extra padding/gel or increase the surface area if necessary.



Swing-away laterals significantly help with transfers and some activities of daily living.

The 3D profile of the back is also important and should encourage the maintenance of the natural curves of the spine.

Respiration can also be affected by scoliosis.

SPINE

Excessive lumbar lordosis associated with anterior tilted pelvis

Aetiology:

- Muscle weakness
- Seeking external sources of support
- Activity based.

Assessment:

Photography.



The following are possible solutions and either one, or a combination, may help:

1. A good quality, tension adjustable back sling with many narrow straps which can be adjusted to encourage 'softening' of excessive lordosis. A standard back sling is inappropriate.
2. Create a rearward sloping seat and carefully set up the back angle to reduce the tendency to lumbar lordosis.
3. Using an adapted tray to form an anterior support for the trunk is often very effective and functional for the user.
4. Padded pelvic positioning accessories (i.e. belts, straps and harnesses) can be used but need to be tight to be effective and are, therefore, not always well tolerated.
5. Open the hip angle by altering the seat angle or using the recline function. Be careful not to cause the pelvis to slide forwards.
6. Tilt-in-space is very beneficial.

Small incremental changes to posture and position are best as these allow the user to adapt to them physiologically.

The most effective solution is to encourage some posterior pelvic tilt using the tilt-in-space function with, or without, recline. The degree of tilt is crucial. This can be assessed by manually tilting the user in his or her wheelchair to see at what angle the tilt becomes effective. At least two members of staff are required for this. The head and arms should be supported to stop the arms falling off the armrests while tilting, preventing the user from accessing the controls.

'Filling in' the lumbar gap is rarely effective and can push the lordotic spine into further hyperextension.

NECK

Weak head and neck control

Aetiology:

- Muscle weakness
- Exacerbated by poor trunk posture
- Poor head control with tilt-in-space and no head support.



Assessment:

Physical assessment.

Simulation of different trunk angles to balance head better.

A finely adjusted degree of recline and/or tilt-in-space with head support can help if the user's head is falling forwards or to rest weak neck muscles during the day. Some users, however, may need to be fully supported at all times. While profiled head supports that give good contact and support are generally well tolerated, some do make the user feel too enclosed or restrict hearing. More minimal head supports are available.



This image is the property of Otto Bock Healthcare Plc

Very rarely and as a last resort, headbands are used to support the head anteriorly. These must be used exceedingly carefully for safety reasons. It is essential that these are secured to prevent the band falling down over the face and/or neck. There is also concern about subluxation of the cervical spine.

Where users have this level of disability, specialist controls are often required. Ensure that the head support is compatible with the controls to be used now and in the future.

A simple head support is enough if the user only requires support when being transported.

A spine which has been fused surgically is usually fixed from cervical to lumbar spine and may not include the pelvis. The fusion may include the pelvis

Aetiology:

- Fused spine and possibly with pelvic inclusion.

Effects:

- Forward flexion only possible from the hips
- New fixed spinal posture
- Activities of daily living tasks must be reassessed.

Assessment:

Range of Movement (ROM).

Functional abilities.

Degree of support required.

Ascertain level of spinal fusion and whether the pelvis is included.

Solutions/management

Solutions and management will depend on the seating and wheelchair prescription made before the operation (pre-op). It is advisable that seating requirements should always be discussed prior to spinal fusion surgery, especially in regions where Wheelchair Services are busy and need to plan ahead. Some centres can offer temporary seating until Wheelchair Services can re-evaluate the user's needs post-op.

1. A mould, or similar, which was used before the operation cannot be used post-op. Alternative interim seating should be arranged as a temporary measure. The seating assessment may need to be undertaken at the user's home as he or she may not be well enough to undergo a seating assessment, or fit enough to travel. Post-op procedures vary from region to region and this should be investigated in advance. Appropriate seating is essential to aid recovery.
2. After spinal surgery, the user often appears taller as the trunk is more extended. If using laterals etc. pre-op, these will need repositioning in the existing wheelchair four or five days after the operation.
3. If the user no longer needs a spinal jacket, the seating will need to be narrowed to provide appropriate support. Existing equipment can be adjusted or new equipment may be required.

A full seating assessment for long-term needs is usually required three to four weeks post-op. This assessment should take into account any changes that may have occurred in functional ability (such as feeding, moving and handling etc).

Use of orthoses

1. Spinal jackets.
2. AFOs.

Many users will at times wear orthoses. A spinal jacket is often worn by users with a scoliosis either instead of, or prior to, surgery.

Spinal jackets – issues to consider:

1. Width issues especially when the jacket is put on/taken off as that can compromise position of lateral supports and armrests (due to spinal collapse).
2. Heat and air circulation.
3. Breast development in girls.
4. Range of materials used.

AFO – issues to consider:

1. Foot support height.
2. Foot support angle.

The height and angle of the footplate may need adjusting for different footwear. Carers and parents need to be aware of these issues at time of supply.

9

FEATURES AND BENEFITS

This chapter includes information about manual and powered wheelchair product solutions that might help people with neuromuscular conditions.

Dealers and representatives of assistive technology companies who provide equipment demonstrations and/or help with provision should be made aware of the clinical issues in the long-term management of neuromuscular conditions. Collaboration between the assistive technology provider and the clinician can produce the best outcome for a user.





"The functions on my new powered chair have given me much more independence, freedom and mobility. The sit to stand function has allowed me to stand and maintain my limited walking ability. In addition, this feature means I can also have direct eye contact at any level. For me, as a conference speaker, this is essential."







Michael McGrath, Inspirational Speaker, Leader and Adventurer, and only person with muscular dystrophy to walk to both the North and South poles.

| PRODUCT TYPE | SPECIFIC OPTIONS | BENEFITS | DRAWBACKS |
|-------------------|--|---|--|
| Buggy | <ul style="list-style-type: none"> ■ Simple umbrella fold ■ Tilt-in-space ■ Various chassis options | <ul style="list-style-type: none"> ■ Lightweight buggies can be useful for a family with several children or who need space in a vehicle to transport other equipment. They are often good as a secondary piece of equipment to aid family lifestyle ■ Often have basic modular seating options (i.e. laterals, lumbar supports) for better seating positions ■ Option for forward or rearward facing seats on some models ■ Can be very useful for families who are not yet ready to accept a wheelchair ■ It can also be used as a transport system (i.e. car seat). The need for fewer pieces of equipment can resolve complex funding issues and may suit a young child who doesn't settle well in different pieces of equipment ■ Child can stay in the same seating system and be transferred onto a home base, a school base, a wheeled base (i.e. buggy type wheels) ■ It may be easy to push and often more compact and lighter than a wheelchair | <ul style="list-style-type: none"> ■ Not very supportive, can only add minimal support or harness. Posture is often compromised for lifestyle needs ■ This more comprehensive buggy type is not as lightweight for families, and often cannot fold down compactly. Only some models are crash tested ■ Families of school age children should be encouraged to investigate wheelchair options to foster a degree of maturity within the child. This can be emotionally challenging for some parents but allowing children to propel independently will improve spatial awareness, decision making and cognitive ability ■ The danger with this is that the child is not getting frequent changes of position. If the seating is not ideal then they have not got an alternative to change into, also makes life difficult when child has to go into bigger seating etc., they then effectively out-grow everything at once |
| Manual wheelchair | Standard self-propelling | <ul style="list-style-type: none"> ■ Independence ■ Essential for longer distances/outside use as walking and exercise tolerance deteriorates ■ Ease of transportation in car | <ul style="list-style-type: none"> ■ Fatigue ■ Potential for repetitive strain injury (RSI) to shoulders, elbows and/or wrists ■ Limited availability of sizes which may require adaptation to match the user's needs. These chairs are mostly made of steel or chrome and are therefore not lightweight |
| | Transit/attendant controlled | <ul style="list-style-type: none"> ■ Ease of transportation in car ■ Essential as back up when powered chair is main form of mobility | <ul style="list-style-type: none"> ■ No independent mobility ■ May not suit carer's needs |

| PRODUCT TYPE | SPECIFIC OPTIONS | BENEFITS | DRAWBACKS |
|------------------------------------|--|---|--|
| High performance manual wheelchair | Many models available with rigid or folding frames, and a range of accessories | <ul style="list-style-type: none"> ■ Custom fit. The choice of seat width, depth and height, back support, arm support, foot support, height and leg support angle ensures that the wheelchair matches the user's size, providing appropriate postural support and discouraging the development of deformities ■ Ease of propulsion/control. The adjustability offered by a high performance manual wheelchair, particularly in the positioning of the rear wheels, ensures a good pushing position ■ The weight distribution between the rear wheels and castors makes this type of wheelchair easier to manoeuvre and 'back wheel balance' than a 'standard' manual chair. It increases independence for all users, particularly those with upper limb weakness ■ Seat height. The seat height can be made higher than in a 'standard' wheelchair, by lowering the position of the rear wheels and modifying the front fork and castor housing. This can greatly benefit users who have difficulty rising from sitting to standing or for environmental access ■ Exercise. Self-propulsion ensures a user is undertaking some physical activity, even if he or she cannot walk. This benefits general health and assists with weight control. Active use of the arms may help maintain strength ■ Increased independence. The ability to self-propel alleviates the need for the user to be accompanied. He or she may be able to dismantle the wheelchair independently and put it in a car ■ Flexibility. This type of wheelchair can be adapted to meet the changing needs of a person with a progressive condition. It alleviates the need for frequent changes of equipment although the set-up of the chair should be reviewed regularly. It is possible to add items such as power-assist wheels to some models, once the user loses the ability to independently self-propel | <ul style="list-style-type: none"> ■ Initial cost ■ The wheels will need to be set up accordingly, allowing for growth and with the ability for adjustment when the current dimensions are outgrown. This may not be as aesthetically pleasing but will be cost effective. |

| PRODUCT TYPE | SPECIFIC OPTIONS | BENEFITS | DRAWBACKS |
|---|---|---|--|
| <p>Power assist self-propelling wheels</p> | <p>Power assist self-propelling wheels</p>  | <ul style="list-style-type: none"> ■ User still 'exercising' and using remaining muscle strength ■ Manual and power assist wheels to be used on same base can be very versatile and decrease storage /transportation issues ■ Limits RSI issues ■ More than one power setting for use in different environments (depending on model) ■ Can be added to manual wheelchair when required (e.g. end of day or over long distances) | <ul style="list-style-type: none"> ■ Limited range ■ Heavy to take on/off ■ Batteries expensive to replace ■ Need to check with manufacturer regarding compatibility and warranty |
| <p>Power assist on manual wheelchair</p> | <p>Joystick control</p> | <ul style="list-style-type: none"> ■ Can be added to manual wheelchair when required (e.g. end of day or over long distances) ■ Easier to transport than powered wheelchair ■ Two products in one ■ Can be funded by second agency ■ Possibly less psychological adjustment required | <ul style="list-style-type: none"> ■ Limited range ■ Less stable, especially on ramps ■ Heavy to lift in/out of vehicle ■ Need to check with manufacturer regarding compatibility and warranty |
| <p>Power wheelchair</p>  | <p>Power chair controlled by joystick</p>  | <ul style="list-style-type: none"> ■ Offers independence over a larger area than possible with manual propulsion ■ Allows user to keep up with peers and facilitates social integration ■ Less fatigue and repetitive strain injury (RSI) ■ Powered seating options available on some models e.g. tilt-in-space, seat lift, powered recline and leg supports ■ Often allows interface with more supportive seating systems ■ Drive profiles are programmed to each individual user at set up ■ Some joystick controls can be upgraded to more sophisticated systems. Consideration needs to be given to this at the time of issue/purchase | <ul style="list-style-type: none"> ■ May be difficult to transport in car due to weight ■ Asymmetric position of joystick (at end of armrest) might lead to postural asymmetry ■ Consideration needs to be given to Health and Safety issues. A risk assessment and driving test may be required ■ Maintenance costs higher than manual ■ Insurance advisable |

| PRODUCT TYPE | SPECIFIC OPTIONS | BENEFITS | DRAWBACKS |
|--|------------------|--|--|
| <p>Tilt-in-space</p>  | <p>Powered</p> | <ul style="list-style-type: none"> ■ User can select appropriate posture for different activities ■ Can reduce/delay the development of scoliosis ■ Uses gravity to help maintain head and trunk control, reducing need for intrusive head supports ■ Enables the user to change his or her position independently ■ Can help reduce the development of neck contractures (which cause decreased function, poor posture and discomfort) if used with a suitable supportive headrest ■ User can rest against the backrest and avoid a dysfunctional forward leaning posture ■ Can reduce the need for intrusive, and often uncomfortable, trunk supports, thoracic pads, harnesses and vests ■ Increases pressure redistribution on the backrest and head support, reducing the load on the user's seating area ■ Aids tissue viability and reduces the risk of pressure ulcers ■ Reduces muscle fatigue and prolonged sitting in one position which can cause postural pain ■ Aids management in recovery following spinal surgery ■ Improved sitting position does not compress internal organs which helps respiration, digestion and elimination ■ Reduces the need for regular transfers (and moving and handling) to lie down, which can interrupt daily life, be socially isolating or impossible to achieve ■ Can help carers to position user in the back of the seat when hoisting into a chair ■ May improve self-esteem and facilitate social integration ■ Reduces social isolation by eliminating or reducing the need to go to bed early when tired ■ Can be used to relax, avoiding need for user to be transferred to a specialist armchair which can cause feelings of isolation | <ul style="list-style-type: none"> ■ Cost ■ Possible incompatibility with user's equipment, e.g. mobile arm support/ventilator |

| PRODUCT TYPE | SPECIFIC OPTIONS | BENEFITS | DRAWBACKS |
|---|--|---|---|
| Recline  | Powered  | <ul style="list-style-type: none"> ■ Recline systems provide a change in orientation by opening the seat-to-back angle and, used with elevating leg rests, open the knee angle too ■ The negative recline function (closing up the hip angle) can be used with tilt-in-space to provide fine adjustments to posture, enabling good head and sitting balance, stability and eye contact ■ Can help maintain Range of Movement at hips and reduces risk of hip contractures developing/progressing ■ Varying the hip angle throughout the day can reduce any pain and/or stiffness ■ Powered recline can assist with toileting in the wheelchair | <ul style="list-style-type: none"> ■ May cause loss of good postural positioning. The use of tilt-in-space may alleviate this problem ■ Cost |
| Seat rise  | Powered  | <ul style="list-style-type: none"> ■ Increased access to all environments ■ May minimise the need for some adaptations to environments ■ May improve eye contact with peers/colleagues ■ Helps compensate lack of lifting ability in the arms | <ul style="list-style-type: none"> ■ Cost ■ May increase seat height so impacting on the access to the user's environment ■ May increase head height impacting on access to user's vehicle |
| Elevating leg supports  | Powered  | <ul style="list-style-type: none"> ■ Change of position can improve comfort ■ Beneficial for circulation ■ Can be used to decrease risk of contractures in knees and hips ■ Can change pressure distribution through feet | <ul style="list-style-type: none"> ■ May not provide adequate leg support for users with knee contractures |

| PRODUCT TYPE | SPECIFIC OPTIONS | BENEFITS | DRAWBACKS |
|--|---|--|---|
| <p>Standing chairs</p>  | <ul style="list-style-type: none"> ■ Manual ■ Powered ■ Manual and powered combination | <ul style="list-style-type: none"> ■ Facilitates functional, purposeful standing during activities ■ Reduces transfers, and moving and handling issues for carers/families ■ Standing without using large pieces of equipment (e.g. static standing frame) allows more dignity <p>General benefits of standing:</p> <ul style="list-style-type: none"> ■ Facilitates natural symmetrical standing posture ■ Develops, improves and maintains upper body balance and strength ■ Improves/maintains range of movement in spine, hips, knees and ankles ■ Provides opportunities for prolonged stretching which helps reduce development of contractures ■ Changing position reduces risk of pressure issues ■ Improves systemic functions (bladder, digestive, respiratory and circulatory) ■ Lessens progressive scoliosis and assists skeletal development ■ Alleviates discomfort by change of position ■ Beneficial psychological effect | <ul style="list-style-type: none"> ■ May cause loss of good postural positioning ■ Possible discomfort ■ Excessive force on joints ■ Cost |

| PRODUCT TYPE | SPECIFIC OPTIONS | BENEFITS | DRAWBACKS |
|----------------------------|---|--|--|
| Specialist control systems | These include: <ul style="list-style-type: none"> ■ different shaped joysticks ■ more sensitive joystick ■ mini joystick ■ proportional head control ■ alternative switches ■ attendant controlled ■ dual controlled | <ul style="list-style-type: none"> ■ As for powered chair ■ Customised control system to suit user's abilities ■ Can be programmed to individual's requirements ■ Can be used to provide assistance, if needed (full or part-time) | <ul style="list-style-type: none"> ■ More complex system ■ User needs to learn new skills ■ More technical skill required to assess and set up ■ Can be harder for carers to drive if needed ■ Cost |

10

PLANNING FOR DIFFERENT ENVIRONMENTS



The introduction of the first wheelchair, whether manual or powered, will inevitably raise concerns for users and carers about access to everyday environments such as home, school, university, workplace and outdoors.

Using a wheelchair will have implications for all these environments as well as affecting private and public transport decisions.

Many users and carers will have planned ahead but others must face the realisation that changes are needed.

10.1 HOME ENVIRONMENT

Ideally, home adaptations need to happen at the same time as wheelchair provision. An assessment of the home environment is essential to ensure it is compatible with the user's long-term needs. Successful adaptations provide access into and around the house and garden, and include enough circulation space to accommodate any future wheelchair.

The Muscular Dystrophy Campaign publishes an Adaptations Manual^[1] to help users and professionals plan suitable wheelchair accessible environments. The manual gives clear guidance on long-term housing needs, space requirements and architectural specifications.

In the past, powered wheelchairs were considered less manoeuvrable than manual chairs, as they required more circulation space. However with technological advances and new products constantly coming onto the market this is no longer always the case. Due to upper limb weakness a user may gain more independence in the home by using a powered wheelchair rather than struggling to self-propel.

1. Harpin P (Second edition – 2003). Adaptations Manual, Muscular Dystrophy Campaign ISBN 0 903561 042.

10.2 SCHOOL ENVIRONMENT



Careful consideration should be given to the school environment of a pupil with a neuromuscular condition. The wheelchair should be compatible with the school environment, both indoors and outdoors. The needs of a pupil will vary as the condition progresses and the level of impairment changes. A pupil who is mobile at the beginning of his or her school life, for example, may be a full-time wheelchair user later. The Muscular Dystrophy Campaign has produced Education Guidelines which provide more information about these issues^[2].

Forward planning is essential, alongside the development of an accessibility plan that the school should adopt. When a pupil begins using a wheelchair it is recommended that the school

undertakes a full risk assessment, an access assessment and a health and safety review. This may also be a requirement of the Local Education Authority (LEA), although it varies from area to area. It may also need to be documented with the LEA.

Wheelchair Services usually conduct their own risk assessment.



2. *Muscular Dystrophy Campaign (2004). Inclusive Education for Children with Muscular Dystrophy or Other Neuromuscular Conditions* ISBN 0 903561 08 5.

Areas to consider are

- Access to school entrance and all classrooms
- Access to, and use of, lifts. Ensure that the lift has adequate space and is safe to take the weight of wheelchair and user
- Circulation space in classrooms and corridors
- Ramped access to emergency exits
- An emergency evacuation plan
- The playground should be safe enough for the child to play independently and socialise with friends
- Access to, and space within, the disabled toilet area
- Access to dining and recreation areas.

School staff need to be aware of their responsibilities regarding the

health and safety of a wheelchair user and his or her relation to other pupils. They may benefit from advice and support from the pupil's therapists.



School transport should be considered when assessing wheelchairs which have electric functions and are likely to be heavier, higher and longer than standard powered wheelchairs. Check the maximum weight capacity for a tail lift as well as maximum head clearance.

10.3 UNIVERSITY

Consider the college, university and/or campus facilities. Contact the college's Student Support Services as early as possible to discuss the student's needs. Grants may be available for additional

equipment. Further advice is available from Disabled Students Allowance (www.student-support-saas.gov.uk/disabled.htm).

10.4 WORKPLACE

Consider the user's work environment when assessing for a wheelchair. The Disability Employment Advisor and/or the Access to Work team may need

to be involved in assessments. Information on these services is available from Jobcentre Plus (www.jobcentreplus.gov.uk).

10.5 TRAVEL/TRANSPORT

Although it is recognised internationally that it is safer to travel in a vehicle seat than in a wheelchair, for many people with a neuromuscular condition this may not be possible. If a user has to travel in a wheelchair, then it should have passed a crash test to a relevant and recognised standard. However, it will not be possible to keep to 'crash tested' equipment while still meeting the user's needs in every case. It is therefore strongly recommended that a risk assessment is undertaken to demonstrate that the risks of using untested equipment are substantially outweighed by the clinical benefits.

The user should be fully involved in the risk assessment process.

Weak neck and shoulder muscles mean poor head control is a common problem for many people with a neuromuscular condition. This means they are at higher risk of whiplash injury. Using a slightly tilted position on a wheelchair when accessing a vehicle by ramp can help maintain good head control and assist transfers into the vehicle.

A head support may help prevent whiplash injury and should be used by anyone with a neuromuscular condition when travelling. The Medicines and Healthcare Products Regulatory Agency (MHRA) recommends that a headrest should be used where other seats fitted to the vehicle also have headrests. A backrest extension may not lie close enough to the user's head and an adjustable headrest, possibly with shaped side supports, may be preferred. When assessing for a wheelchair consider the user's vehicle including sufficient headroom, four point restraints, suitable anchorage points, and method of accessing the vehicle.

Some users may wish to drive from their wheelchair. Mobility Advice & Information Service (www.dft.gov.uk/access/mavis) and the Forum of Mobility Centres (www.mobility-centres.org.uk) can offer relevant advice and assessment. The Department of Transport (www.dft.gov.uk) may also be able to help.

10.6 OUTDOOR ENVIRONMENT

Wheelchair users who use their chairs on the road are at greater risk than other road users and this is not reflected in current road safety laws.

There is currently no standardised training for users to ensure that the

increased mobility provided by their chair is not decreasing their safety or minimum fitness standards, such as eyesight standards or other health issues. The wheelchair and the user must be visible in poor light or darkness. Lights and reflective strips for the

wheelchair, and reflective clothing for the user, are essential for safety. (Most Wheelchair Services do not provide these.) Lights come as an optional extra on some powered wheelchairs but are easily damaged and expensive to replace. Bicycle lights are a cheaper option and can be mounted onto the wheelchair frame without the need for drilling. Reflective strips can also be bought at most cycle shops and be used to customise the wheelchair.

"I would really like to have lights on my chair so people can see me when I go out now it's dark, and I would like to paint it red."

Imran, 13 (Duchenne muscular dystrophy)

For the purpose of some regulations, Class 2 and Class 3 powered wheelchairs are not classified as motor vehicles. In view of this, certain parts of the Road Traffic Acts do not apply to powered wheelchair users, e.g. the

sections on dangerous driving, driving while under the influence of alcohol or drugs, and use of mobile phones while driving.

Class 2 and Class 3 powered wheelchairs are currently prohibited from using motorways, cycle lanes, and bus lanes but are allowed on dual carriageways providing they display a flashing amber beacon.

Class 2 and Class 3 powered wheelchairs are exempt from excise duty but should display a valid 'exempt from taxation' vehicle excise certificate. They should also be registered with the Driver and Vehicle Licensing Agency (DVLA) but are not required to display a registration plate.

For more information read Get Wise – Highway Code for electric wheelchair and scooter users, available from the British Healthcare Trades Association (www.bhta.net) or the Department of Transport's Code of Practice for Class 3 vehicle users.

10.7 SPECIALIST WHEELCHAIR TRAINING

Life in a wheelchair can be very restricting, especially if the user has to rely on family, friends or carers to get around the neighbourhood or even into the garden.

It can feel even more restricting for children as they watch their friends play outside but are unable to join in. All children need to get out and about, play, enjoy the fresh air and spend time with friends. Children who use wheelchairs are no different.



Perhaps more than their peers, they need to move safely around their home and neighbourhood and participate in the daily activities at school and home that others take for granted.

In the street, children who use wheelchairs need to learn how to get up and down kerbs, deal with traffic and pedestrians, and negotiate crossings and parked cars. A child needs the confidence and skills to develop his or her individual way of living, and growing, with the wheelchair. They need to learn how to use their wheelchair to reach out and broaden their horizons so they can realise their full potential.

The Association of Wheelchair Children (www.go-kids-go.org.uk) runs the following training courses, throughout the UK, for children who use wheelchairs:

- Manual wheelchair course
- Powered wheelchair course
- Course for professional healthcare workers
- Road safety wheelchair course.

The Royal Society for the Prevention of Accidents (www.rosipa.com) has produced a leaflet called *A Framework towards Developing Wheelchair Proficiency for Manual and Powered Wheelchair Users*.

Whizz-Kidz has set up a scheme called *Wheelchair Skills Training* which teaches children the vital skills they need to be in control of their wheelchair. The schemes are led by adult wheelchair users who act as trainers, role models and advisers for the children, parents and other professionals. They lead activity-based sessions that cover spatial awareness, route planning, road safety, wheelchair maintenance, pushing/driving techniques and back-wheel balancing and are suitable for both manual and powered wheelchair users to attend.

Please visit www.whizz-kidz.org.uk/gethelp/wheelchairtraining or call **020 7233 6600** for more information.

10.8 PUBLIC TRANSPORT

See appendix 3 for information on public transport.

APPENDICES

APPENDIX 1

NEUROMUSCULAR CONDITIONS

The term 'neuromuscular conditions' is used to describe a group of mostly genetic disorders, which are generally progressive. They cause loss of muscle strength and sometimes this deterioration can happen quickly.

There are over 60 types of neuromuscular condition, including muscular dystrophy. The age of onset varies between, and within, conditions. Some conditions, such as Duchenne muscular dystrophy, always begin in childhood while others start to affect individuals in adulthood.

Included here is brief information about the most common neuromuscular conditions. More detailed factsheets are available from the Muscular Dystrophy Campaign. Telephone the Information and Advice Line on 0800 652 6352 or download the factsheets from www.muscular-dystrophy.org/factsheets

BECKER MUSCULAR DYSTROPHY

Becker muscular dystrophy is an X chromosome condition. It is a milder variant of Duchenne and boys/men with the condition experience similar problems to those with Duchenne. The condition varies in severity. It can be almost as severe as Duchenne or mild enough only to be diagnosed later in adult life. Some of those with Becker muscular dystrophy will lose the ability to walk in early adult life, but others remain ambulant into middle age and beyond.

CHARCOT-MARIE-TOOTH DISEASE, ALSO KNOWN AS HEREDITARY MOTOR AND SENSORY NEUROPATHY

Charcot-Marie-Tooth disease has a variable inheritance pattern. It may first be noticed in childhood, affecting the small muscles of the hands (and fine motor movements) and feet (high arches, foot drop and 'club foot' may be symptoms). Some people with the condition experience mild weakness and may not even be aware they have the condition, while others are severely affected and have great difficulty in walking.

CONGENITAL MUSCULAR DYSTROPHIES

These are a collection of different muscular dystrophies characterised by weakness at birth or soon after. Occasionally a congenital muscular dystrophy may be diagnosed a little later. The severity of the condition depends on the type of congenital muscular dystrophy diagnosed. Early life problems include floppiness (hypotonia), poor head control, contractures, respiratory problems, swallowing and feeding difficulties. Some children may also have learning difficulties. While many children are never able to walk, others do achieve delayed walking but lose this ability as they grow older.

CONGENITAL MYOPATHIES

This group of conditions usually causes muscle weakness in children, although in some cases there are no symptoms until adulthood. Respiratory problems are a common feature and scoliosis, cardiac problems and contractures can also be factors, depending on the type of myopathy.

DUCHENNE MUSCULAR DYSTROPHY (DMD)

Duchenne muscular dystrophy is a serious condition and the most common of the childhood onset muscular dystrophies. It is caused by a fault on the X chromosome so the condition only affects boys, although their mothers may be carriers. About 10 boys with Duchenne are born each year in the UK and, at any one time, approximately 1,500 boys are living with the condition. The risk for the general population of having an affected child is 1:3,500 male births.

Duchenne is often, although not always, characterised by late walking (after 18 months). Further early signs include calf hypertrophy (enlarged calves) and muscle weakness in the lower limbs causing loss of balance. An affected child also finds it difficult to get up from the floor or use stairs. As the condition progresses, a distinctive walk emerges; to compensate for the increasing weakness in the hip and pelvic muscles the boy will walk on his toes with his abdomen pushed forward. A child may also have contractures (stiffness) of the heels and ankles, which may require surgery.

APPENDICES

Some boys with Duchenne have learning difficulties, particularly with language and communication skills. These difficulties are rarely severe and do not worsen over time.

Boys with Duchenne lose their ability to walk, usually after the age of nine, and then become full-time wheelchair users. From this point onwards, they may experience scoliosis (curvature of the spine), cardiac problems, weakness of the shoulders, arms and hands, chest infections and, at a later stage, respiratory problems. Life expectancy is reduced. In the past, most boys died in their late teens. Today, with assisted non-invasive ventilation, they can survive into their late twenties and beyond, which poses new long-term management issues.

FACIOSCAPULOHUMERAL MUSCULAR DYSTROPHY (FSH)

FSH is an inherited condition that can affect men and women. The first signs are usually weakness in the face and shoulder muscles which make it difficult for the individual to raise his or her arms. A 'winging' of the shoulder blades is also apparent

Weak facial muscles can affect speech, communication and feeding. The muscle which raises the foot is often affected early on in the condition – causing people to trip – along with the lower (distal) leg. This weakness can then spread to the larger hip girdle muscles. The rate at which the condition progresses is variable, although it is usually true that the earlier the symptoms, the more severe the eventual muscle problems. A minority of people will experience complete loss of walking, but others may also need a wheelchair for long distances and to prevent fatigue. Some people may have hearing loss.

INCLUSION BODY MYOSITIS

This is not an inherited condition. Inclusion body myositis is the most common form of muscle weakness acquired in later adult life. It causes substantial disability and is characterised by weakening muscles in the hands and thigh, which can cause falls. Swallowing may also be affected. Although other forms of myositis (muscle inflammation) respond to treatment, it is generally ineffective with this form of the condition.

LIMB GIRDLE MUSCULAR DYSTROPHIES (LGMD)

These are a group of progressive muscle conditions affecting both males and females. The limb girdle group of muscular dystrophies are so called because they usually cause weakness in the shoulder and pelvic girdle. Weakness in the legs generally occurs before weakness in the arms. The muscles of the face are usually unaffected. The condition progresses at a variable rate. Some children will be severely affected while others will not be diagnosed until adulthood. Some forms of limb girdle muscular dystrophies affect the heart and breathing.

METABOLIC MYOPATHIES

Contracting a muscle requires energy. The body metabolises the food eaten into a form of energy the muscle can use. Many inherited disorders affect the metabolic pathways. Some, such as McArdle's disease or mitochondrial myopathies, cause exercise intolerance (the person has no symptoms at rest but develops muscle pain and weakness if he or she attempts activity). Others, such as Pompe's Disease or debrancher enzyme deficiency, cause progressive weakness regardless of whether exercise is undertaken or not. Some metabolic myopathies also affect the heart and respiratory muscles.

MYOTONIC DYSTROPHY AND CONGENITAL MYOTONIC DYSTROPHY

Myotonic dystrophy and congenital myotonic dystrophy are dominantly inherited conditions that tend to increase in severity from one generation to the next. The majority of those affected will begin showing symptoms in early adulthood but it is not uncommon for children of affected mothers to have the more serious congenital form of the condition. Both men and women are equally likely to be affected.

A characteristic feature of these conditions is the myotonia or muscle stiffness (a delayed relaxation of the muscle following contraction) which is often worse in cold weather and more of a nuisance than a disability. More problematic, however, is muscle weakness in the hands, ankles, face and neck. Affected individuals may also experience smooth muscle problems causing trouble with the gut (pain, similar to that experienced in Irritable Bowel Syndrome, has been known to occur).

A significant feature of the conditions, particularly congenital myotonic dystrophy, is learning difficulties, which can be severe. People with myotonic dystrophy may also exhibit sleepiness; tiredness, lethargy and cataracts at an unusually early age are not uncommon. The heart may also be affected and cardiac monitoring is recommended for both adults and children. It is unlikely, however, that an individual would have all the symptoms and problems associated with such a variable and complex condition.

SPINAL MUSCULAR ATROPHY (SMA)

SMA is a recessively inherited condition that causes muscle weakness. It affects both boys and girls equally. The severity of the condition depends on the type of SMA and age of onset.

SMA type I is the most severe form of the condition. Children with type I are very weak and lack motor development. They cannot sit unaided and have difficulty breathing, sucking and swallowing. Most do not survive beyond their first birthday.

SMA with Respiratory Distress Type 1 (SMARD1) causes muscle weakness but the predominating symptom is severe respiratory distress due to paralysis of the diaphragm. Babies between one month and six months old experience respiratory failure and progressive muscle weakness, mainly in the distal lower limbs. Sensory and autonomic

nervous systems may also be involved. SMARD1 is distinguishable from SMA Type I by the paralysis of the diaphragm and distal muscle weakness. Infants with SMA Type I become floppy due to weakness of the proximal limb muscles, assuming a 'frog leg' position, before they suffer respiratory failure due to paralysis of intercostals muscles.

SMA type II is slightly less severe than SMA type I. Children with type II can sit unaided and even stand with support, but cannot walk. They do not usually have difficulties with feeding and swallowing but are at increased risk of complications from respiratory infections. Some children will not live into adulthood.

SMA type III is milder than SMA type II. Children with type III can stand and walk. They may outgrow their muscle strength and many do eventually need to use a wheelchair. SMA type III affects children after 18 months of age.

SMA type IV is the least common form of the condition and usually begins in late adolescence or adulthood. It has a similar clinical course to Becker muscular dystrophy and was often misdiagnosed as such in the past.

For more information about all forms of SMA, call The Jennifer Trust for Spinal Muscular Atrophy on 0870 774 3651 or visit its website at **www.jtsma.org.uk**

APPENDICES

APPENDIX 2

CLINICAL/CARE MANAGEMENT THAT IMPACTS ON WHEELCHAIR PROVISION

1. SPINAL PROBLEMS

In young children with conditions such as Spinal Muscular Atrophy type II, some congenital muscular dystrophies, congenital myotonic dystrophy and some of the congenital myopathies, muscle weakness is present at or soon after birth. These children may begin to develop spinal curvature very early in life, often soon after they begin to be supported in the sitting position. In children with Duchenne muscular dystrophy, scoliosis often develops soon after they become unable to walk. This may also be the case in children with conditions such as Spinal Muscular Atrophy type III, some of the congenital muscular dystrophies and other muscle conditions if the ability to walk is lost during childhood. The curve may be a scoliosis with or without rotation, an increased lumbar lordosis or an increased thoracic kyphosis. All of these curves will have an effect on the position of the pelvis and the head.

As muscles weaken, the level of disability increases and the person becomes less mobile, spending much of the time sitting. The spinal curvature tends to progress, resulting in increasing difficulty in sitting. The arms are needed for support, thus reducing upper limb function. Although initially mobile, the curves may become fixed over time resulting in an alteration of the shape of the chest and a restriction in the capacity of the lungs. This further compromises breathing in people who are already likely to have weakened respiratory muscles. Clearly, it is very important to try to delay the onset and slow the deterioration of a progressive scoliosis so that breathing remains as efficient as possible and sitting remains comfortable. This will also assist in maintaining maximum upper limb function.

It is felt by many therapists working within the field of neuromuscular conditions that it may be possible to delay the development of spinal deformities using appropriate supportive seating and tilt-in-space wheelchairs.

Management

There are two direct management options: bracing, using a spinal jacket, or surgery to fuse the spine permanently.

i) Bracing

Spinal jackets are used successfully in some children to stabilise the spine while they are sitting, however they are unlikely to prevent a curve from progressing (Muntoni et al 2006). Jackets may be used in very young children to try to maintain posture while allowing some growth to take place. In some areas of the country there is reluctance among spinal surgeons to use bracing at all as it is felt to compromise respiratory function.

ii) Spinal surgery

Consideration is likely to be given to surgery as soon as it becomes evident that a curvature is going to lead to postural problems and eventual respiratory impairment. The right time to perform surgery needs to be decided in consultation between the young person and his or her family, the spinal surgeon, the neuromuscular team and the anaesthetist.

The possibility of surgery needs to be considered in very close relation to the child's respiratory and cardiac function. For most children there is a 'window of opportunity' when their respiratory and cardiac function is at a suitable level. If surgery is not carried out during this time, the option is permanently lost due to unacceptably high levels of anaesthetic risk.

It is not usually necessary to consider surgery in very young children when years of rapid spinal growth lie ahead, unless the deformity is severe. However, some children with SMA, or congenital conditions may require surgery at a young age (this can be as young as four or five years old). More than one operation may be needed to accommodate the child's growth.

Surgical stabilisation of the spine is a major operation and is not without significant risk. Careful assessment is needed when considering it and the risks need to be balanced against the benefits. There are a number of spinal surgeons in the UK who regularly perform stabilisation surgery on patients with neuromuscular conditions. They will all have slightly different procedures and protocols. It is therefore vital that each individual patient and his or her family discuss the exact nature of the surgery with their own consultant and ask for detailed information on the risks and expected outcomes.

Stabilising the spine, from just below the neck to the pelvis, significantly restricts the mobility of the trunk which, in a healthy person, would be a distinct disadvantage. In a child with a neuromuscular condition this movement is already impaired so it is not such a great problem. However, some children find that eating is more difficult after the operation because they can no longer lean forward to get their mouth nearer to their hand. This problem can often be overcome following assessment by an occupational therapist who will be able to advise on the provision of suitable equipment.

The aims of the spinal surgery are to:

- stabilise the spinal column and prevent further deterioration
- improve and maintain sitting posture
- eliminate the need for a spinal brace
- remove the need to provide support to the trunk with the upper limbs
- improve head position due to better trunk posture and stability
- delay the deterioration in respiratory function
- eliminate the need for excessive padding and bracing when sitting
- improve comfort.

It will be essential for the spinal team, therapists and the Wheelchair Service to liaise prior to surgery to discuss the user's post-operative wheelchair and seating requirements, and any alterations or additional features (such as powered tilt-in-space) that may be needed.

2. RESPIRATORY MANAGEMENT/DAY TIME VENTILATION

Many different neuromuscular conditions cause weakness of the breathing muscles. This can affect both children and adults at any age. Regular monitoring of respiratory function is usually organised by the user's consultant as there is a risk of developing symptoms of nocturnal hypoventilation if breathing overnight becomes too shallow to maintain adequate oxygen levels in the blood. Symptoms may be any one or more of the following:

- Night-time waking
- Headache on waking, which lessens after about 30 minutes
- Daytime sleepiness
- Repeated chest infections
- Loss of appetite
- Poor concentration and memory.

Symptoms can be successfully treated with non-invasive positive pressure ventilation via a mask to assist with breathing. Initially it is used only at night, however many people progress to needing it during the day, either intermittently or permanently. Occasionally, a person with a neuromuscular condition will be ventilated via a tracheostomy. The wheelchair **must** be able to accommodate all the essential ventilation equipment.

Ventilation equipment considerations:

- The wheelchair needs to be suited to the user, not just their equipment
- Ventilator (consideration of type, size, access, power supply)
- Possible need for humidifier, back-up battery, suction machine, oxygen, bag and mask, spare tubing, suction catheters etc.
- Environments where wheelchair will be used, including distances
- Transportation arrangements, including power in transit
- Health of carer
- Size if user is a small child (i.e. is a specialised buggy suitable for the child and able to accommodate all the equipment required?)
- Tilt testing of chair, user and all equipment.

APPENDICES

NB: Users need to be provided with both powered and manual wheelchairs that meet their clinical needs and have capacity to carry all the necessary equipment.

Maintenance and insurance of ventilation equipment is usually organised by the providing Health Authority and the company supplying the equipment.

3. MOBILE ARM SUPPORTS

Neuromuscular conditions cause progressive weakness and many of them affect the muscles of the shoulder girdle at an early stage. However, deterioration in the muscles of the forearm and hand is slower. Once a certain level of shoulder weakness is reached, the weight of the arm cannot be supported and active use of the shoulder is lost. At this stage, if the elbow is supported, movement of the forearm and hand can still be utilised. Many people develop alternative methods of movement such as bringing the head to the hand, using one arm to support the other or “creeping” the fingers along a hard surface. Such compensatory methods cause the development of abnormal postures and allow only limited functional use of the arm. Loss of the use of the arms is one of the most frustrating and debilitating aspects of neuromuscular conditions.

To enable improved function, some users may be supplied with a single or pair of powered, height-adjustable mobile arm support/s in which their forearm is supported in a sling and the arm is raised and lowered using a switch. The device enables frictionless, gravity-eliminated movement at a range of heights. It gives the user a wider reach, increasing the range of tasks that can be performed and providing many physical, social and psychological benefits.

The device is usually attached to the back of the user's powered wheelchair and may affect total length and width as well as the possible use of tilt-in-space and recline facilities. Liaison with the user's therapist/s and the company supplying the equipment is essential. Discussion will need to take place about the safe use of the combination of arm support and wheelchair in different situations. For further information see the Muscular Dystrophy Campaign's factsheet on powered mobile arm supports. Contact the Information and Advice team on 020 7720 8055 or visit www.muscular-dystrophy.org/factsheets

4. ENVIRONMENTAL CONTROLS

Neuromuscular conditions cause progressive muscle weakness affecting the legs, arms and trunk muscles and often result in users having a very high level of disability and very limited function.

Some users will use environmental controls to enable them to perform tasks independently such as working audio-visual equipment, managing the telephone, turning lights on/off, drawing curtains around the home. They may also use such a system for monitoring and allowing access to callers.

There are many different systems available on the market, some of which may need to be fitted onto the wheelchair, so liaison with the user and the team involved with supplying their equipment will be essential.

APPENDIX 3

PUBLIC TRANSPORT

INTRODUCTION

Wheelchair users can only take their place and play a full role in society if they have good, accessible public transport. The positive effects of accessible public transport cannot be underestimated. Being able to use public transport can improve self-esteem, quality of life, and independence as well as having social and economic benefits.

ACCESSIBILITY

Public transport has radically changed since the 1990s and much more is now accessible to wheelchair users. Each transport type has a deadline for compliance with the Disability Discrimination Act (DDA): Buses (single) 2016, buses (double) 2017, coaches 2020, trains 2025. By 2025 all public transport in London should be accessible to wheelchair users.

All Hackney Carriage licensed taxis in London have been wheelchair accessible since 2000. Regulations are still being developed for taxis operating elsewhere. Advisory services, such as RADAR and the local authority, can provide further information for wheelchair users.

All new trains, coaches, buses and taxis will be wheelchair accessible. (Some trains, buses and coaches built before the regulations may be accessible but not be of as high a standard as regulated transport.) Light railways, metro and tram services are all accessible.

An increasing number of service providers will be providing better information for users on which services are accessible as well as offering tips on travelling in a wheelchair.

Further information about the DDA regulations for wheelchair accessibility on public transport is available from the Department of Transport. For more information visit its website at www.dft.gov.uk

SAFE TRANSPORTATION OF WHEELCHAIR USERS

Not all types of wheelchair are suitable for public transport. DDA regulations, which stipulate that all new transport must be wheelchair accessible, do not cover buggies or scooters.

Below are the dimensions of a wheelchair which could travel on all vehicles that comply with the regulations. This is not the only type of wheelchair able to travel.

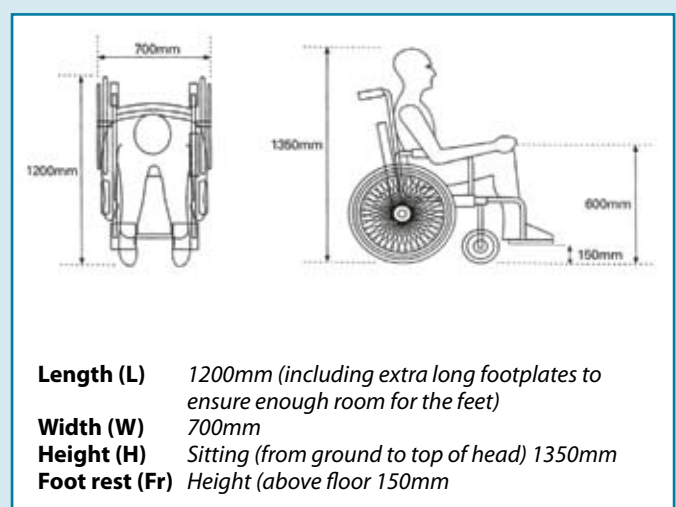

Users with an extra large wheelchair, buggy or scooter may want to contact the relevant transport operator for help and advice.

TRAVELLING BY BUS AND TRAIN

A bus driver may be unable to help a wheelchair user onto the bus. Anyone travelling alone, and requiring assistance, should contact the local bus operator to find out what help is available. There are no wheelchair restraints on a bus, just an upright pad and rail. On a train there is only an upright pad. Some train stations may not be accessible.

Ramps used to board buses and trains can vary in height because of kerbs and platforms. Although most wheelchairs have anti-tip devices, care should still be taken when negotiating ramps.

APPENDICES

Users should be aware of the limitations of their own wheelchair regarding inclines, sideways tilt and detachable accessories that can impact on safe travel. Users are responsible for ensuring their wheelchair is in serviceable condition, for example tyres correctly inflated so that brakes work efficiently and effectively.

Many door-to-door services are also available, including Community Transport, Dial-A-Ride and other voluntary schemes. Most of these services use wheelchair accessible vehicles that have been adapted by specialist companies. These companies are not governed by any legal standards. A certificate of approval can be issued to the vehicle and, while this is not a legal requirement, it gives users confidence in the vehicle's roadworthiness.

The certificates of approval are:

- EC Whole Vehicle Type Approval (ECWVTA), a European community certificate
- Low Volume Type Approval (LVTA) obtained through the Government's certification scheme. This includes testing of seats and seatbelt anchors in a collision
- Single Vehicle Approval (SVA), a cheaper inspection of a converted vehicle, similar to an MOT.

Managers of door-to-door services should always undertake risk analysis/management schemes so that transport staff are aware of the possible adverse effects of wheelchair transportation. Disability awareness training, as well as training in the correct choice and fitting of wheelchair tie-down and occupant restraint systems (WTORS), should be mandatory for all staff involved in transporting wheelchair users.

Vehicles should always carry different types of WTORS so that all wheelchairs can be transported safely. When applying user restraints, consideration should be given to the most suitable type, and the correct positioning for the wheelchair user.



Accessories are sometimes needed by a wheelchair user during travel. These should be secured safely and may require padding. Good communication skills are vital for staff involved in transporting wheelchair users, to ensure maximum safety and respect for the user's rights.

CRASH TESTING OF WHEELCHAIRS IN ROAD PASSENGER VEHICLES

There has been some crash testing of wheelchairs – using crash sleds and dummies – to assess the safety of wheelchair users when travelling in road passenger vehicles. These tests have usually simulated an impact at 30 miles per hour in a vehicle seating up to eight passengers. Tests have also been carried out on the Optare Excel low floor bus. The dummies used simulate fit, able-bodied adults.

All the tests show that the most vulnerable parts of the body for wheelchair users are the head and neck. Testers recommended that head and back restraints be fitted in all vehicles carrying wheelchair users.

Vertical shoulder straps are not suitable for use with belt restraints, as they increase the risk of injury. Lap and diagonal belt restraints are recommended.

There are advantages and disadvantages to sitting in a rear or forward facing position, depending on the type and size of vehicle, anchorage variations, restraints, and size of the wheelchair user.

Powered wheelchairs cannot always get close to the back and neck restraints, because of battery containers and gears. This gave rise to greater injuries in the tests.

The tests concluded that it was impossible for a passenger seated in a wheelchair to be given the same degree of protection and safety as a conventionally seated person. Changes were recommended to vehicles, restraints and wheelchairs but it was accepted that none would be made in the foreseeable future due to costs.

USEFUL PUBLICATIONS

Wheels within wheels. 2005. Ricability
www.ricability.org.uk

The safety of wheelchair occupants in road passenger vehicles. 2003. Department of Transport

Guidance on the safe transportation of wheelchairs. 2001. MDA

Guidance on the stability of wheelchairs. 2004. MHRA

Get wheelwise – a wheelchair user's guide to public transport. BHTA www.bhta.com

APPENDICES

APPENDIX 4

HIGH PERFORMANCE MANUAL WHEELCHAIRS

There are now many high performance manual wheelchairs available. The frames are rigid or folding and made from a variety of materials. Seat width, seat depth and backrest height can be specified to meet an individual's needs and most manufacturers provide a range of accessories. The rear wheels are usually 'quick release' and adjust up and down in the frame, to change seat height and angle. They can also move backwards and forwards to adjust the balance position. (Castor housings and forks adjust to accommodate the movement of the rear wheel.)

Benefits of this type of wheelchair for people with neuromuscular conditions:

CUSTOM FIT

The choice of seat width, height and depth, height of the backrest, armrest and footrest ensures that the wheelchair fits the user. A good fit promotes good postural support and discourages postures which could cause deformities to develop.

EASE OF PROPULSION/CONTROL

The positioning of the rear wheels and the use of lightweight materials make these wheelchairs easier to push and manoeuvre than standard manual wheelchairs. The rear wheels are positioned in front of the backrest which enables the user to easily perform a 'back wheel balance' that aids independent use and control. Low profile, high-pressure tyres are also beneficial.

HIGH SEAT

The seat height can be increased by moving the rear wheels down the frame and adjusting the front fork and castor housing assembly. Increased seat height can help users who are still able to stand. Full-length armrests are also beneficial. A careful assessment of the way the user moves from sitting to standing will be needed to help decide the choice of frame style and footplate.

INCREASED INDEPENDENCE

Increasing the ability to self-propel may reduce the need for the user to be accompanied and pushed. The light frame and quick release wheels may also mean that some users can lift the wheelchair into, and out of, their car.

EXERCISE

Even if a user is no longer able to walk, self-propulsion ensures that he or she is undertaking some physical activity. This benefits general health and assists with weight control. This type of wheelchair can encourage active use of the arms which may help maintain muscle strength.

ASSESSMENT

Representatives from most companies selling this type of wheelchair can usually attend assessments and provide information on the technical specifications of the wheelchair. While many of these representatives are very experienced at assessments, they are unlikely to know about the needs of users with neuromuscular conditions. It is recommended that a suitably experienced therapist is present at any assessment.

High performance manual wheelchairs are under-issued for users with neuromuscular conditions, possibly because the criteria of many Wheelchair Services exclude the provision of this type of wheelchair to anyone other than a full-time user. This type of wheelchair can benefit users with a neuromuscular condition by improving health, slowing deterioration and increasing independence.

APPENDIX 5

FUNDING

In the 1990s the Muscular Dystrophy Group (now the Muscular Dystrophy Campaign) successfully campaigned for state funding of indoor/outdoor powered wheelchairs. This was a huge move forward and gave independence to thousands of people^[1].

However, high specification powered wheelchairs with the necessary functions to improve people's mobility and that meet clinical need are still expensive, and NHS Wheelchair Services' budgets are inevitably limited. The Muscular Dystrophy Campaign published a report in June 2004 – *Hard Pushed: How the NHS Fails Powered Wheelchair Users*^[2] – which concluded that the Government must provide ring-fenced funding for the NHS Wheelchair Services to meet people's needs.

There are huge regional variations in eligibility criteria for provision and funding^[3]. Funding has not been ring-fenced and the Muscular Dystrophy Campaign continues to campaign with other charities for change.

In the meantime, service managers are often willing to look at creative ways of providing the right wheelchair. Some Wheelchair Services have considered and used various joint initiatives to enable the most appropriate wheelchair and seating to be provided.

These have included:

A) WHEELCHAIR VOUCHER SCHEME

This was introduced in 1996. The aim of the scheme is to give disabled people more choice of wheelchairs within the NHS by offering them three options:

1. To accept the wheelchair prescribed
2. To contribute to the cost of a more expensive wheelchair of their choice. They own the chair and are responsible for its maintenance and repair. **This is the Independent option**

3. To contribute to the cost of a more expensive wheelchair of their choice, from a range selected by the local Wheelchair Service. The NHS will own the chair and be responsible for its maintenance and repair. **This is the Partnership option.**

The key principles of these schemes are:

- Universal eligibility – anyone assessed as meeting the local eligibility criteria for a wheelchair may apply
- Assessment and review of needs by the Wheelchair Service and prescription of a suitable wheelchair in consultation with the user
- Supply of the wheelchair through agreed suppliers
- Continued access to NHS provision of special seating if required.

A voucher represents the cost to the NHS of providing a new wheelchair that, in the opinion of the NHS therapist or other qualified professional, would meet the clinical needs of the user.

In the **Independent Option** the voucher usually includes an amount for maintenance and repair costs for the period of the voucher, e.g. four or five years.

Initially the voucher scheme was used for provision of self-propelled wheelchairs only but some areas have extended the scheme to include provision of powered wheelchairs, including those with powered functions such as tilt-in-space.

At present, the voucher scheme is only available in England. In the West of Scotland wheelchairs are currently provided using joint funding with one or more charities and with NHS agreeing responsibility for maintenance. In Wales, Wheelchair Services will consider joint funding with charitable organisations. In Northern Ireland, fully funded powered wheelchairs are available for everyone who meets the Northern Ireland Wheelchair Service's criteria.

References

1. *Batteries Not Included* (1993). Muscular Dystrophy Group of Britain and Northern Ireland.
2. *Hard Pushed: How the NHS Fails Powered Wheelchair Users* (2004). Muscular Dystrophy Campaign. ISBN 0 903561 09 3.
3. Audit commission report "Fully Equipped 2000".

APPENDICES

B) JOINT FUNDING WITH CHARITIES AND/OR PARENTS

Wheelchair Services can work with charities and/or parents to find funds to purchase specialist wheelchairs to meet agreed clinical need. Grants may be found to pay for functions such as powered tilt-in-space, recline or riser.

A grant from a charity combined with Wheelchair Service funds may enable equipment to be purchased quickly rather than be delayed on a waiting list.

C) WHEELCHAIR SERVICES STAFF TO HELP WITH THE PRIVATE PURCHASE OF A SUITABLE POWERED CHAIR

Discussion between Wheelchair Service staff and the user/parents/carer during assessment can help with the provision of the best possible equipment, even if it cannot be provided by NHS Wheelchair Services.

D) FUNDING FROM SOME WHEELCHAIR SERVICES TOWARDS MAINTENANCE AND REPAIR OF PRIVATELY PURCHASED POWER BASE

Some Wheelchair Services have taken on the maintenance and/or repair of a privately purchased or charity funded chair. This can be up to a previously agreed limit and instead of providing a powered chair.

E) FUNDING FROM WHEELCHAIR SERVICES OF SPECIAL SEATING IN A PRIVATELY PURCHASED POWER BASE

Many Wheelchair Services allow special seating to be interfaced into privately purchased power base in addition to the NHS power base.

It is frequently easier to obtain charitable funding for high specification wheelchairs for children than for adults, and families may choose this option.

However, users are entitled and will need to return to NHS provision as adults. There are independent assessment centres. There may be a suggested charge for some of these services.

In some areas part-funding for a wheelchair can be obtained through social services or Local Education Authority (LEA) or by special appeal to the Primary Care Trust (PCT).

If purchasing a private wheelchair, even if funded through a charity, it is very important to discuss who will be responsible for maintenance or how these costs are to be met. This is especially important for a user who has an active lifestyle and is probably more likely to need repairs to his/her wheelchair.

Forging good partnerships and collaborative working between agencies can help ensure the best provision for every individual.

MUSCULAR DYSTROPHY AND NEUROMUSCULAR CONDITIONS ORGANISATIONS

MUSCULAR DYSTROPHY CAMPAIGN

61 Southwark Street
London SE1 0HL
Tel: **020 7803 4800**
Email: info@muscular-dystrophy.org
Web: www.muscular-dystrophy.org

BECKER UNITED

Email: tjd.davies@ntlworld.com
Web: www.beckerunited.com

CLIMB (CHILDREN LIVING WITH INHERITED METABOLIC DISEASES)

CLIMB Building,
176 Nantwich Road
Crewe CW2 6BG
Tel: **0870 7700 326**
Web: www.climb.org.uk

CMT UNITED KINGDOM

PO Box 5089
Christchurch BH23 7ZX
Tel: **0870 7744 314**
Email: Secretary@cmt.org.uk
Web: www.cmt.org.uk

DUCHENNE FAMILY SUPPORT GROUP

78 York Street
London W1H 1DP
Tel: **0870 606 1604** (*helpline*)
E mail: info@dfsg.org.uk
Web: www.dfsg.org.uk

THE JENNIFER TRUST FOR SPINAL MUSCULAR ATROPHY (JTSMA)

Elta House
Birmingham Road
Stratford upon Avon
Warwickshire CV37 0AQ
Tel: **0870 774 3651**
Helpline: **0800 975 3100** (*9am to 9pm*)
Email: jennifer@jtsma.org
Web: www.jtsma.org.uk

MYOSITIS SUPPORT GROUP

146 Newtown Road
Woolston
Southampton
Hampshire SO19 9HR
Tel: **023 8044 9708**
Email: msg@myositis.org.uk
Web: www.myositis.org.uk

MYOTONIC DYSTROPHY SUPPORT GROUP

35A Carlton Hill
Nottingham NG4 1BG
Tel: **0115 987 5869**
Email: mdsg@tesco.net
Web: www.mdsguk.org

MUSCULAR DYSTROPHY AND NEUROMUSCULAR CONDITIONS ORGANISATIONS

MYOTUBULAR TRUST

10 Penshurst Close
Chalfont St Peter
Buckinghamshire SL9 9HB
Tel: **07813 200298**
Email: contact@myotubulartrust.com
Web: www.myotubulartrust.com

NEMALINE MYOPATHY

5 Cairnbank Gardens
Penicuik
Midlothian EH26 9EA
Tel: **01968 674998**
Web: www.nemaline.org

PARENT PROJECT UK

Epicentre
41 West Street
London E11 4LJ
Tel: **020 8556 9955**
Email: info@ppuk.org
Web: www.ppuk.org

SBMA UK

(This group covers spinal bulbar muscular atrophy also known as Kennedy's Disease.)
57 Keysbrook
Tattenhall
Cheshire CH3 9QP
Tel: **01829 771 266**
Email: info@sbma.org.uk
Web: www.sbma.org.uk

OTHER ORGANISATIONS

ASSOCIATION OF WHEELCHAIR CHILDREN (AWC)

6 Woodman Parade
North Woolwich
London E16 2LL
Tel: **0870 121 0055**
Email: northteam@wheelchairchildren.org.uk
Web: www.wheelchairchildren.org.uk

CARERS UK

20 Great Dover Street
London SE1 4LX
Tel: **020 7378 4999**
Email: info@carersuk.org
Web: www.carersuk.org

CONTACT A FAMILY

209 – 211 City Road
London EC1V 1JN
Tel: **0808 808 3555**
Email: helpline@cafamily.org.uk
Web: www.cafamily.org.uk

DISABILITY ALLIANCE

Universal House
88 – 94 Wentworth Street
London E1 7SA
Tel: **020 7247 8776**
Email: office.da@dial.pipex.com
Web: www.disabilityalliance.org

DISABILITY LAW SERVICES

Ground Floor
39 – 45 Cavell St.
London E1 2BP
Tel: **020 7791 9800**
Email: advice@dls.org.uk
Web: www.dls.org.uk

ASSIST UK – DISABLED LIVING CENTRES COUNCIL

4 St. Chad's Street
Manchester M8 8QA
Tel: **0870 772 0866**
Email: general.info@assist-uk.org
Web: www.assist-uk.org

DISABLED LIVING FOUNDATION

380 – 384 Harrow Road,
London W9 2HU
Tel: **020 7289 6111**
Web: www.dlf.org.uk

FAMILY FUND

Unit 4, Alpha Court
Monks Cross Drive
Huntingdon
York YO32 9WN
Tel: **0845 1304542**
Email: info@familyfund.org.uk
Web: www.familyfundtrust.org.uk

MOBILITY INFORMATION SERVICE

20 Burton Close
Dawley
Telford TF4 2BX
Tel: **01743 340269**
Web: www.mis.org.uk

MOTABILITY

City Gate House
22 Southwark Bridge Road
London SE1 9HB
Tel: **0845 456 4566**
Web: www.motability.co.uk

OTHER ORGANISATIONS

RADAR

12 City Forum

250 City Road

London EC1V 8AF

Tel: **020 7250 3222**

Email: **radar@radar.org.uk**

Web: **www.radar.org.uk**

WHIZZ-KIDZ

Elliot House

10 – 12 Allington Street

London SW1E 5EH

Tel: **020 7233 6600**

Email: **info@whizz-kidz.org.uk**

Web: **www.whizz-kidz.org.uk**

ROYAL SOCIETY FOR THE PREVENTION OF ACCIDENTS (ROSPA)

RoSPA House

Edgbaston Park

353 Bristol Road

Edgbaston

Birmingham B5 7ST

Tel: **0121 248 2000**

Email: **help@rospa.com**

Web: **www.rospa.com**

PUBLICATIONS – FURTHER READING

Adaptations Manual 2nd Edition (2004)

Muscular Dystrophy Campaign.
ISBN 0 903561 04 2

Guide to Handling Patients,

National Back Pain Association,
16 Elmtree Road,
Teddington,
Middlesex TE11 85T
Tel: **020 8977 54 74**

Inclusive Education for Children with Muscular Dystrophy or Other Neuromuscular Conditions (2004)

Muscular Dystrophy Campaign.
ISBN 0 903561 08 5
Can be ordered at
info@muscular-dystrophy.org

Making it Work – Removing Disability Discrimination (2002)

National Children's Bureau.
Can be ordered from
www.ncb-books.org.uk

Manual Handling Guidelines,

Flash Ley Resource Centre,
Hawksmoor Road,
Stafford ST17 9DR
Tel: **01785 356830**

Muscular Dystrophy: The Facts (2000)

Alan Emery,
Oxford University Press.
ISBN 0192632175

The Muscular Dystrophies (2001)

Alan Emery,
Oxford University Press.
ISBN 0192632914

Myotonic Dystrophy, The Facts (2002)

Peter Harper,
Oxford University Press.
ISBN 0198525869

Raising a Child with a Neuromuscular Disorder (1999)

Charlotte Thompson
Oxford University Press.
ISBN 0195128435

FURTHER REFERENCES

Steroid treatment and the development of scoliosis in males with Duchenne muscular dystrophy.

Alma, Raza, Biggar (2004)

Pelvic obliquity after fusion of the spine in Duchenne muscular dystrophy.

Alma, Raza, Kim (1999)

Seating and spine support for boys with Duchenne muscular dystrophy.

Carlson, Payette (1987)

Seating the child with musculoskeletal weakness.

Neen, Beauchamp (1987) **Steroid treatment and the development of scoliosis in males with Duchenne muscular dystrophy.**

Alma, Raza, Biggar (2004)

PUBLICATIONS – FURTHER READING

Guidelines on seat correction for wheelchair users with neuromuscular disease.

Sorenson, Anderson (1994)

Surgical stabilisation of the spine in Duchenne muscular dystrophy.

Weimann, Gibson, Moseley, Jones (1993)

The patterns of spinal deformity in Duchenne muscular dystrophy.

Wilkins, Gibson (1972)

Survival in Duchenne muscular dystrophy.

Eagle et al (2002)

Muscular Dystrophy Campaign funded workshop on management of scoliosis in Duchenne muscular dystrophy.

Muntoni et al (2005)

GLOSSARY OF TERMS

Abduction (Abd)

A movement away from midline.

Abduction Wedge

Also known as bilateral medial thigh support. Used to cause the thighs to abduct in response to an adduction pattern.

Adduction (Add)

A movement toward midline (Adding).

A.D.L.

An abbreviation for 'Activities of Daily Living' or 'Aids to Daily Living'. It is concerned with such things as dressing, eating, hygiene, etc.

Aetiology

Cause, the study of cause.

Airless Insert

This is used in some pneumatic tyres instead of an inner tube to make it puncture-proof, but still with all the benefits of a rubber tyre.

ALR (Articulating legrest)

Articulating legrest – used in place of a swing-away legrest to support a leg in an elevated position greater than 60 degrees. Does not need to have footplate re-adjusted for length each time there is a big difference in angle, unlike the ELR.

Anodized

Optional durable, special finish available on many Quickie frames. Appearance is metallic.

Anterior (or Ventral) (Ant)

Towards the front.

Anterior Thoracic Support

A component of a seating system designed to provide anterior support to the thoracic area (i.e. Butterfly or H-Harness).

Anti-tip

A detachable, add-on device to help prevent a wheelchair tipping over backwards.

Anti-inflammatory

A drug (e.g. brufen) used to treat conditions associated with inflammation.

Articulating legrest (ALR)

Please see ALR.

Arthrodesis

Surgically induced fixation of a joint.

ASIS/ASIC

Anterior Superior Iliac Spine/Anterior Superior Iliac Crest – located on the pelvis and used as landmarks in the assessment of sitting posture.

Asymmetrical

Not symmetric.

Atrophy

A wasting away or diminution in the size of cells, tissue, organs or parts.

Axilla

The arm pit.

GLOSSARY OF TERMS

Axle/axle plate/axle sleeve/axle pin

All associated with the centre of the rear wheel and its attachment to the wheelchair. The plate is the metal 'bar' which takes the axle sleeve, through which the axle pin slides. The pin is frequently QR (quick release) and slides through the centre of the wheel and locates into the axle sleeve, mounted to the axle plate.

Bottoming-out

This is said to have occurred when a user, sitting on a cushion, compresses it so much that his/her bones make contact with some part of the base of the cushion.

Bucket

The amount of rearward slope of a wheelchair seat. Also known as dump, rake and squeeze.

Calcaneum

Heel bone.

Camber

This is the amount rear wheels are angled out, so that the gap between the top of the wheels is less than where they make contact with the floor.

Camber bar/washers/spacers

Depending on model of wheelchair, these are all ways of obtaining or adjusting the amount of camber on a chair.

Castor float

When a castor wheel loses contact with the floor occasionally or continually. This should be checked.

Castor housing /stem /fork /stem bolt

These are all parts of the front wheels of a wheelchair. The housing is the barrel, the stem is the part that goes into the barrel, the fork is the part where the castor wheel is mounted and a stem bolt is an extra length that can be added between the housing and the fork.

Castor Square

Used for checking castor alignment.

Catheter

A hollow flexible tube that can be inserted into a vessel or cavity to withdraw or instill fluids, e.g. urinary catheter goes into the bladder and causes urine to pass out of the body. Normally a urinary catheter is passed through the urethra to the bladder, but sometimes users have a 'suprapubic' catheter that is surgically (under local anaesthetic) passed through the abdomen wall and into the bladder. Most users then have a collection bag attached to their leg or furniture (e.g. bed at night) to collect the urine.

Centre of Gravity (CoG/Centre of Mass)

The mid-point or centre of the weight of an object or body.

Cervical Spine (C-spine)

Area of the spine associated with the neck-consisting vertebrae.

Chronic

A disease or disorder that is slowly progressing and persisting over a long period of time.

Clammy

Description of 'sweaty' skin – used in assessment of risk of developing a pressure sore. (Waterlow)

GLOSSARY OF TERMS

COG/COM – Centre of Gravity/Mass

The mid-point or centre of the weight of an object or body.

Cognition/cognitive/cognitive deficits

The mental processes of knowing, thinking, learning, memory, comprehension and judging. Sometimes affected with brain damage.

Communication aid/device

This may be anything that aids communication from pen and paper and pictures to a high tech computer with voice synthesizer. Some need to be mounted to the wheelchair.

Congenital

Present at birth.

Contracture

A condition of fixed-high resistance to passive stretch of muscle caused by not maintaining a full range of motion at the joint.

Course of a disease

How a disease progresses.

Cross-brace

On a folding chair – this is the part under the seat in an X shape that moves as the chair is folded/unfolded. A double cross brace has two pairs of bars e.g. Swede Cross.

Cross-spoked

This is a rear wheel with the metal spokes crossing each other between the hub and the rim. Also see radial-spoked.

Decubitus ulcer/pressure sore

The sore is a breakdown of skin and superficial tissues caused by prolonged pressure on a specific area. Usual sites of such sores are areas where a bony prominence is at or near the skin surface and subject to the pressure of sitting or lying in one position.

Depth Adjustable Back

An anterior – posterior adjustment built into the back of a seating system that allows the system to accommodate for growth by opening up usable seat depth.

Discoloured skin

This is used as a description on the Waterlow Scale for pressure sore risk. Here the skin is red or blue/red after sitting and remains like this for 30 minutes.

Dislocation

Displacement of any part of the body from its normal position. Typically a bone from a joint.

Distal

Used in reference to the extremities and meaning farther from the attached end (body), away from the trunk.

Dominance (hand)

The favoured limb for fine activities, e.g. writing. Important to ascertain with brain injury.

Dorsiflexion

Typically used to describe the action of bending the ankle so that the foot points upwards. Can also be used to describe other parts of the body.

Doubly incontinent

A user who is incontinent of urine and faeces.

GLOSSARY OF TERMS

Drop-in-Seat

A term used to indicate the position of a custom seat surface between or inside the wheelchair seat rails. This seat configuration is most frequently used in order to achieve a lowered seat height.

ELR (Elevating legrest)

Elevating legrest used where an angle of less than 60 degree is required and there is little angle adjustment needed once it is set. If the angle needs to be changed regularly, use the ALR (Articulating legrest) to overcome the problem of having to keep re-adjusting the footplate length.

Environmental Control System/Unit (ECS/ECU)

A mechanical or electrical system that allows disabled persons to control devices or appliances in their environment.

Ergonomics

The study and analysis of human work, especially as affected by the human body. In wheelchair prescription this relates to the optimal wheelchair settings for maximum efficiency and minimum stresses.

Exacerbation

An increase in the severity of any symptom or disease.

Extension

Straighten out a limb or the trunk (i.e. reaching or opening fingers).

Extensor

A muscle that straightens or extends a limb (i.e. wrist extensor).

External Rotation

Twisting a joint outward (away from the body).

Facilitation

This is the assistance a therapist or other gives to a user to aid a movement or action.

Femur

Long bone of the leg between the knee and the hip.

Fender guard

A (usually) detachable, height adjustable, plastic side guard on a wheelchair that resembles a mud-guard.

Fine Motor Skills

Functional movement involving fingers, hands, head, neck and eyes.

Fixed deformity

A posture that is not possible to change conservatively (i.e. without surgery), for example, scoliosis.

Fixed front end

A wheelchair with a rigid footrest support and without swing-away foot hangers. It may have a flip-up option but side-frame remains sticking-out at the front.

Fixing

A non-reflexive postural pattern where one might see a rigid type posture of either flexion, extension or both in the trunk extremities, neck, mouth and eyes. Such patterns are frequently exhibited in an effort to compensate for a lack of proximal stability.

GLOSSARY OF TERMS

Flexion / Flexing

Bending or being bent.

Flexor

A muscle that bends a limb, part of a limb or the trunk.

Folding Wheelchair

A wheelchair with a cross brace (single or double) that can be folded side to side; or a wheelchair with the ability to fold front to back.

Foot-print

The amount of wheel that makes contact with the ground.

Foot-propulsion

A method of propelling a wheelchair by using the feet/foot in contact with the ground.

Foot strap/toe strap

Used to keep the foot on the wheelchair footplate. Maybe Velcro and/or buckle fastened.

Full profile polyurathene

Black solid tyre with minimal tread and limited traction.

Fusion

The fixing – usually surgically – of bones or joints, e.g. spinal stabilisation when scoliosis present.

Gastrostomy/PEG feeding/‘Button’

A surgically created opening through the abdomen into the stomach through which a tube is passed to allow liquid nutrition when normal eating and drinking is impossible.

Goniometer

Instrument used to measure the precise angle of joints to limbs.

Grommet

An eyelet of firm material to strengthen or protect an opening. Frequently used with a shoulder harness and solid back.

Gross Motor

Functional movement involving the large muscles of the body. Movement of the arms, legs and trunk. Opposite – fine movement.

Guard – side/fender/spoke/impact guard

These are used to protect the body or wheelchair from damage. Side guards come in a range of styles including fender guards. Spoke guards are mounted to the rear wheel and are there for protective and aesthetic reasons. Impact guards are fixed to the front frame/hangers to protect the finish and/or the user from damage.

Hammocking

Seen in a badly sagging back or seat slings, usually due to wear. A sag of over 40mm is unacceptable as it increases the risk of pressure sores.

Handrim/handgrip

The metal or coated metal rim on the rear wheels that is used when self-propelling. Options: anodized aluminium, steel, heat treated, plastic or foam coated.

Heat treated rims

These are available with performance rear wheels only. They are lighter than standard tennis and basketball wheels. Their appearance is charcoal grey and they measure one inch bigger than on the prescription forms.

GLOSSARY OF TERMS

Heel-loop

This is a fabric or cloth strap that is mounted to a footplate and positioned behind the heel, to prevent the foot sliding backwards or interfering with the castor wheel. The foot should not be slid under it.

H/P – High Performance

This describes a high 'spec' light weight chair, usually a rigid wheelchair. Some people use this to describe a sports wheelchair.

High Pressure Clincher (HPC)

A type of light-weight, durable, high pressure pneumatic tyre.

Hub Brake

An attendant braking system fitted to the hub of a wheelchair and operated from the push handles.

Hyperextension

Extension of joint beyond its normal range of movement.

Hypersensitivity

Excessive reaction to a particular stimulus, e.g. touch, sound.

Hypertonic/hypertonicity/spastic/ high tone

Abnormal increased muscle tone or strength.

Hypotonic/hypotonicity/flaccid/low tone

A condition characterised by low tone and floppy movements.

Hypoxia

Inadequate cellular oxygen, characterised by cyanosis (blueness of extremities and lips).

IA – Inferior Angle

The lowest 'corner' on the scapular/shoulder blade.

Iliac Crest/spine (ASIS + PSIS)

The superior most outer edge of the pelvis.

Incontinence

Inability to control bladder and/or bowels adequately. Doubly incontinent means incontinence of urine and faeces.

Inferior

Further from the head.

Internal rotation

Twisting motion of a joint inward (toward the body).

Ischaemic

Decreased blood supply to a body organ or part often causing pain or dysfunction. Important in the development of pressure sores.

Ischial Tuberosities (ITs)

The two bony prominences at the base of the pelvis which, in sitting, protrude downward.

Kyphosis

An abnormal curvature of the spine with a posterior convexity (hunch back) often also associated with scoliosis.

Lag

The amount a joint range of motion is limited by, e.g. extension lag of knee of 10 degrees.

Lateral

Away from midline.

GLOSSARY OF TERMS

Lateral Head Support

A component of a seated positioning system that maintains the head in an upright forward facing position.

Lateral Pelvic Support

A component of the seated positioning system that aligns the hips (pelvis) in a medial lateral position.

Lateral Thoracic Support

A component of the seated positioning system that aligns the trunk in a medial position.

Latex tubular/sew-up/Continental tyre

A pneumatic tyre without an inner tube. Orange in colour.

Lordosis

Abnormal curvature of the spine with an anterior (inward) convexity (sway back).

Lumbar

The inferior/medial portion of the spine, posterior to the abdomen.

Lumbar Support

A component of the seating system used to support or promote the normal amount of extension and curvature in the lumbar spine. Sometimes referred to as a lumbar roll.

Medial

Nearer to the midline of the body.

Muscular dystrophy

A group of genetic conditions that are either inherited or arise 'out of the blue'. There are no cures or treatments which prevent the breakdown of muscle. There are many different types and the severity and impact on life varies considerably, although there is always some level of disability.

Neuromuscular

Pertaining to both nerve and muscle.

NG Tube/Feed (Nasogastric)

A tube that is passed down the nose into the stomach to provide fluids and nutrition when normal eating and drinking are impossible. Also see 'gastrostomy/PEG feeding'.

Non-verbal communication

This describes all ways of communication without speech – drawing, signing, communicators, body language.

Obliquity

See 'pelvic obliquity'.

Occipital

Relating to the occiput on the skull.

Oedema/oedematous

The pressure of abnormally large amounts of fluid in the intercellular tissue spaces of the body commonly referred to as swelling.

Orthopaedic

A branch of medicine studying and treating the skeleton, joints, muscles and associated structures. Orthopaedic appliances include callipers, braces, orthotics and splints.

Orthosis/orthotics (splints/braces)

An externally worn device that either supports or corrects to increase the function of the body segment it covers.

Paediatric

Referring to children.

GLOSSARY OF TERMS

Pelvic floor

This describes the muscles at the base of the pelvis, between the legs. It includes the muscular sphincters that control the opening of the anus and urethra. When they are weak incontinence can result.

Pelvic obliquity

Pelvic movement in a frontal plane about a sagittal horizontal axis in such a manner that one iliac crest is lowered and the other is raised. Obliquity is named in terms of the side that moves downward (also referred to as a 'lateral pelvic tilt').

Pelvic rotation

Pelvic movement in a transverse plane about a vertical axis approximating the longitudinal axis of the spine.

Pelvic tilt

Pelvic movement in a sagittal plane about a frontal – horizontal axis (i.e. anterior, posterior and neutral pelvic tilt).

Planar

This describes a flat surface with no contours.

Plane

An anatomical reference of body position.

Plantar Flexion

Bending of the ankle so the foot points downwards.

Popliteal (Popliteal Fossa)

Pertaining to the area of depression of the region of the back of the knee.

Posterior (or Dorsal)

The back side or skull side.

Pressure sore

See Decubitus ulcer.

Primary diagnosis

The main thing that is medically wrong with someone. Secondary diagnoses are the other more trivial things that are wrong with them, but still are important to know about, e.g. diabetes.

Proclined back

Any angle anterior (forward) to zero degrees vertical, superior edge leading.

Prognosis

Forecast as to the course and/or outcome of a disease or injury.

Prone

Face side down or palm side down.

Proprioception

Sensation relating to stimuli originating from within the body regarding spatial position and muscular activity or to the proprioceptors.

Proximal

Used in reference to the extremities and meaning nearer to the attached end (to the body).

PSIS

Posterior Superior Iliac Spine.

Push handles/stroller handles

These are used for attendant pushing. Stroller handles mount in low receivers at the rear of the chair and are mainly on paediatric chairs.

GLOSSARY OF TERMS

Quick Release (QR)

Refers usually to parts that can be detached by depressing a small pin/button, e.g. rear wheel axles where the central hub pin/button can be depressed to remove the wheels. Castors and backs can also have a QR mechanism to remove them.

Radial spokes

These are used mainly on the performance and heat-treated wheels (cf. cross-spoked).

Rake

Refer to the slope on the seat of a wheelchair. Also known as dump, squeeze and bucket.

Range of Movement (ROM)

The ability to rotate, extend or move a segment of the body.

Recline

Any angle posterior to zero degrees vertical, superior edge leading.

Reflex

Involuntary invariable muscle response to a stimulus e.g. knee jerk.

Rehabilitation Engineering/Rehab engineer

Field of engineering that applies mechanical, electrical and bio-mechanical principles to solving the problems of the physically disabled.

Rigid wheelchair

A wheelchair that typically does not fold, nor does it have removable footrests.

Rim

This describes the edge of the trough where the tyre sits on the wheel. In performance wheels this can be higher or double walled for strength and to prevent the tyres rolling off the rims, primarily in sports activities.

Roll resistance

This is the ease with which the tyres overcome the friction/traction of the ground. The easier it is to propel the lower the resistance.

ROM (Range of movement)

The ability to rotate, extend or move a segment of the body.

Rotation

Twisting of a joint.

Sacrum/Sacral position

Sacral position is when the user has slid down in the chair and is then sitting on his or her sacrum.

Scapula

Shoulder blade

Scoliosis

Lateral curvature of the spine.

Secondary diagnosis/condition

Anything else that is wrong with a user after their main diagnosis (primary), e.g. primary is Duchenne muscular dystrophy, secondary is diabetes or pressure sore.

Shoulder protraction

Results from abduction of the scapulae, movement of the shoulders in a superior direction.

GLOSSARY OF TERMS

Sling

1. Material used in seat and/or back of a wheelchair to form a base of support. It may be tension adjustable.
2. Material used in conjunction with a hoist to lift a user from one surface to another safely.
3. Material used to support an injured arm.

Soft tissue

Referring to muscle and tendon.

Sore

See Decubitus ulcer.

Spasticity/spasm

Involuntary increased tension in a muscle or muscle group. Partial or complete loss of voluntary control of the affected area.

Splint/splinting

See 'orthotics'.

Stepper tube

Used by attendant to tilt the chair backwards, e.g. for kerb climbing.

Stretcher bar

Used by some companies to tension the back sling.

Subluxation

Partial dislocation.

Superior

Toward the head.

Supine

Face side up, palm side up.

Support surface

This describes anything that a user leans on – the seat, cushion, back, armrests, footrests.

Suprapubic catheter

See 'catheter'.

Swing-away – footrests/armrest/tray table

This describes a component that can be fixed in one position for use, but be easily swung away when not required or for transfers.

Tabs

These are the permanent connectors which mount the handrims to the rear wheels.

Thoracic

Referring to the part of the body between the neck and the abdomen or lower back.

Tilt-in-space

Generally refers to anterior/posterior tipping of an entire seated positioning system while maintaining seat-to-back angle. (Also referred to as angle-in-space.) Lateral tilt is also used with positioning systems.

T-in-T/Tube in tube

Describes the profiled down-tubes that mount the footplates in the hangers.

Toe in and toe out

This is the description for fine adjustment of the rear wheels, which is equivalent to the 'tracking' adjustment of car wheels.

GLOSSARY OF TERMS

Toe strap/foot strap

Used to keep the foot on the footplate.
Maybe Velcro and/or buckle fastened.

Tolerance Build-Up Program

A schedule for the initial use of a seated positioning system.

Tone

The tension in resting muscles, the state of readiness in a muscle.

Transfers

This is the action of getting from one piece of furniture (e.g. bed or wheelchair)/fixture (e.g. WC)/floor to another.

Trunk

This is the main body of a user – not including their arms, legs and head.
Trunk balance is the same as sitting balance.

TS

Stands for tilt-in-space.

Turning circle

This is the amount of space a wheelchair or castor requires to complete a 360 degree turn.

Ulceration

Breakdown of the skin.

V-frame (various angles available on rigids/70 degree foot hangers)

This describes the shape of the front-end of a wheelchair, where the sides are narrower at the bottom than top.

Wheelbase

The measurement of the distance between the wheels – front to back and/or side to side.

Wheel lock

Also know as parking brake.

Wind-swept

This describes an abnormal posture of the legs where they both veer to one side of the chair so the user is slightly rotated. This is often due to muscular imbalances and should be corrected where possible.

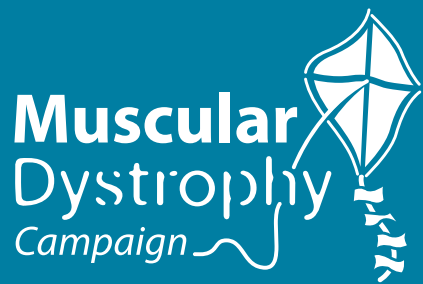

61 Southwark Street, London SE1 0HL
www.muscular-dystrophy.org
020 7803 4800
0800 652 6352 (freephone support line)
www.muscular-dystrophy.org

Design: PruAgency, Prudential
Photography: Richard Bailey –
richard@richardbaileyphotography.co.uk

Registered Charity No. 205395 and Registered Scottish Charity No. SC039445
Publication code:WG-Comms-June06/5k